

HPSII Phosphate Mine

Alachua County Concerns

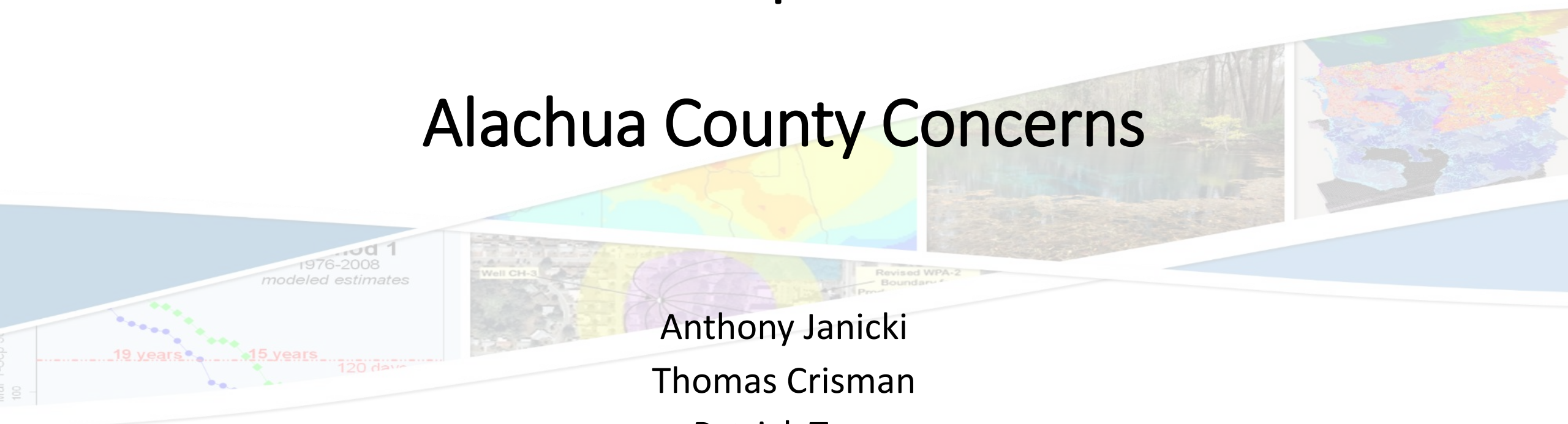

Anthony Janicki
Thomas Crisman
Patrick Tara
Sam Upchurch

Outline

- Surface/Ground Water Related Concerns
- Mine Reclamation Concerns
- Hydrogeological Concerns
- Minimum Flows and Levels Concerns
- Nutrient Concerns
- Wetland Concerns

Surface/Ground Water Related Concerns

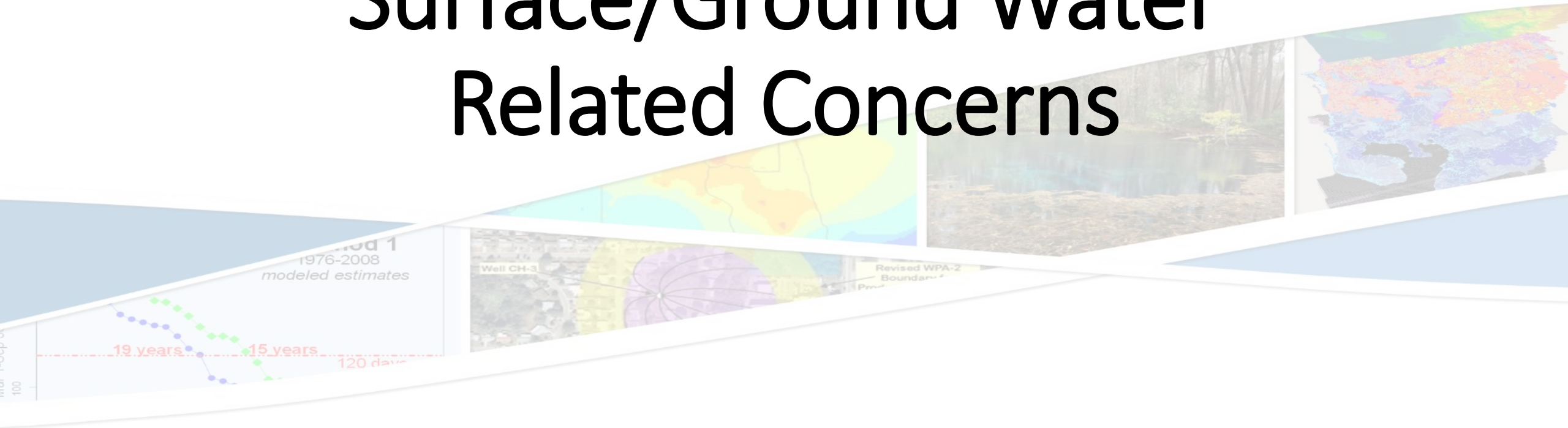

Surface Water

- **Mine wide** surface water budget Pre-Mining/Active Mining/Post Reclamation Continuous Simulations –
 - Only event-based mine wide models were documented, due to the nature of New River MFLs continuous hydrologic modeling for the whole study area will be required
 - Continuous models were developed but not for the entire mine area, focus on GW impacts not SW
 - Obtain/develop a surface water model for Pre- and Post- mining condition
 - The addition of the proposed lakes will increase AET
- Proposed consumptive use (impacts to water table impact vadose zone and therefore runoff)
- How is the sand/clay mix different from existing soils (sand/clay mix will impact runoff/infiltration)

SW Pre- and Post-mining Mine Wide Basin Modeling

- SW modeling was event based
- Continuous model is required to evaluate impacts to the MFL

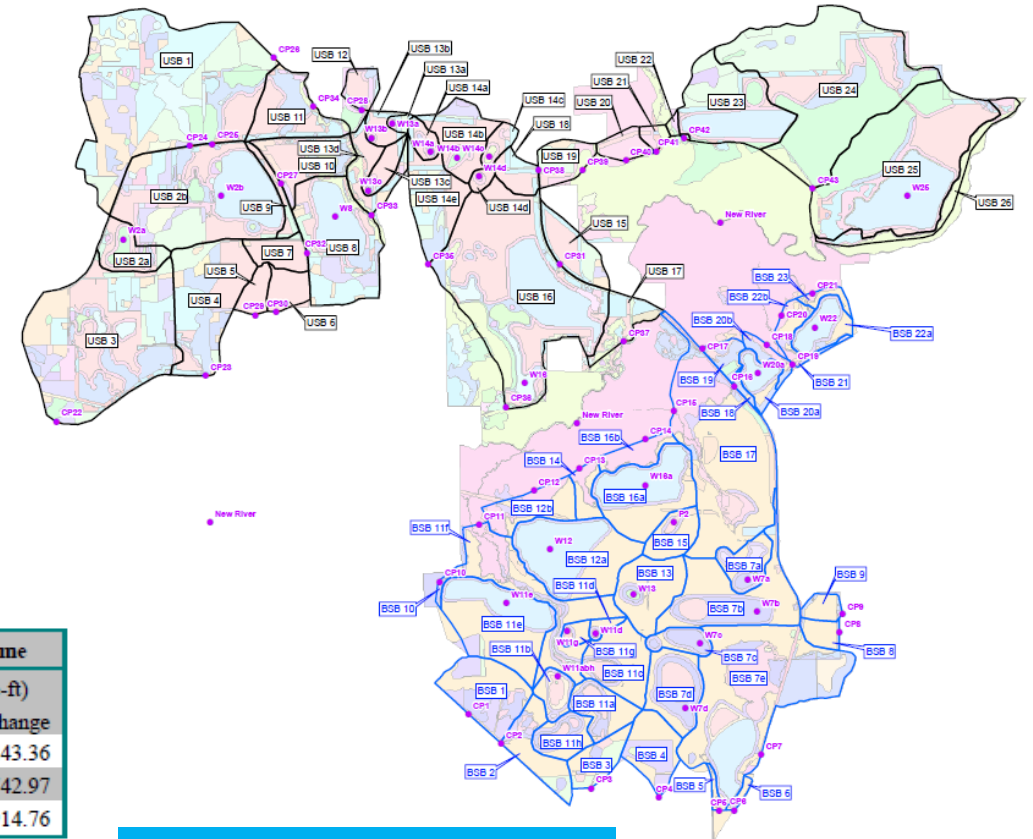

Table 7.4 Bradford County Total Peak Flow Rate and Runoff Volume

Storm Event (24 Hours)	Peak Flow Rate (cfs)			Runoff Volume (acre-ft)		
	Pre	Post	Change	Pre	Post	Change
Mean Annual	675.1	394.29	-280.81	668.44	425.08	-243.36
25-Year	1964.76	1168.63	-796.13	1975.85	1232.88	-742.97
100-Year	2689.87	1628.15	-1061.7	2739.13	1824.37	-914.76

Table 7.5 Union County Total Peak Flow Rate and Runoff Volume

Storm Event (24 Hours)	Peak Flow Rate (cfs)			Runoff Volume (acre-ft)		
	Pre	Post	Change	Pre	Post	Change
Mean Annual	1271.87	815.61	-456.26	1339.44	1019.51	-319.93
25-Year	3204.52	2108.45	-1096.1	3329.55	2534.01	-795.54
100-Year	4400.46	3304.58	-1095.9	4426.44	3508.84	-917.6

HydroCAD Version 10.0 was used for Pre- and Post- mining phase stormwater analysis



PROJECT NO. 2016103.001A
 DRAWN: 8/3/2017
 DRAWN BY: CTC
 CHECKED BY: E
 FILE NAME: Appendix F Pre-Mining Phase Drainage Map.mxd

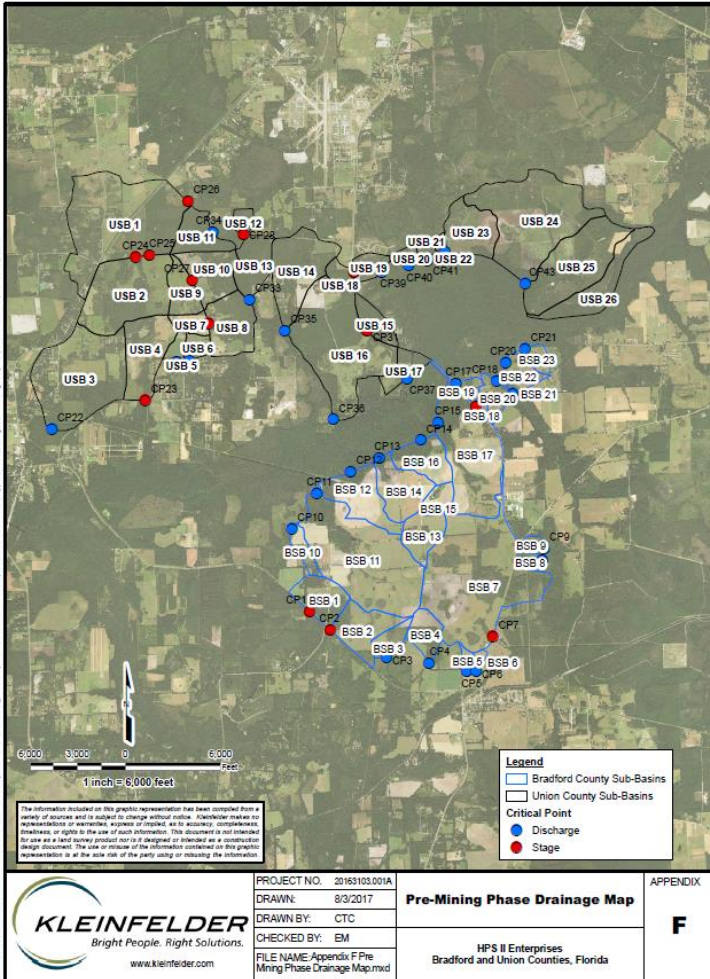

KLEINFELDER
Bright People. Right Solutions.
www.kleinfelder.com

PROJECT NO. 2016103.001A
 DRAWN: 8/3/2017
 DRAWN BY: CTC
 CHECKED BY: EM

Pre-Mining Phase Drainage Map

HPS II Enterprises
Bradford and Union Counties, Florida

APPENDIX **F**

Evaluation of New River Flow -- RAI Attachment 6

- Purpose of this study was to determine the pre-mining condition relative to the stage and discharge of the River and several of its tributary
 - Station No. 1 (Five Mile Creek)
 - Station No. 2 (New River)
 - Station No. 3 (Unnamed Southwest Tributary)
 - Station No. 4 (Unnamed Southeast Tributary)

Figure 1. Annotated Topographic Map with Stream Gage Stations

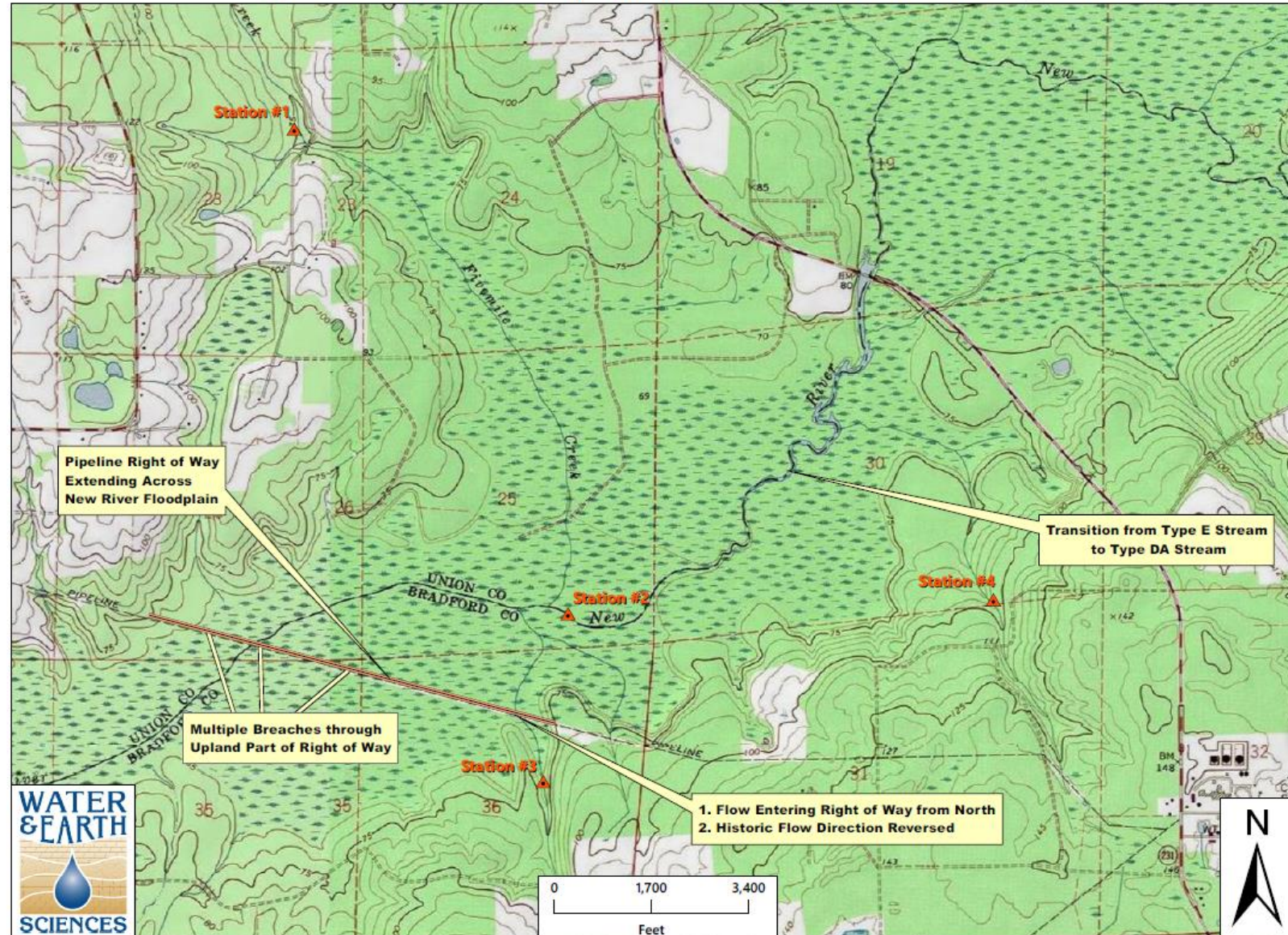

Evaluation of New River Stage/Discharge Relationship

- Stage/Discharge relationship should not be changing since river and riparian area are not directly impacted
- Point calibration does not account for shoaling present throughout the system, Figure 8
- Spreadsheet models are poorly constrained at high flows
- Does not address the impacts to flow from changes in land use/land cover

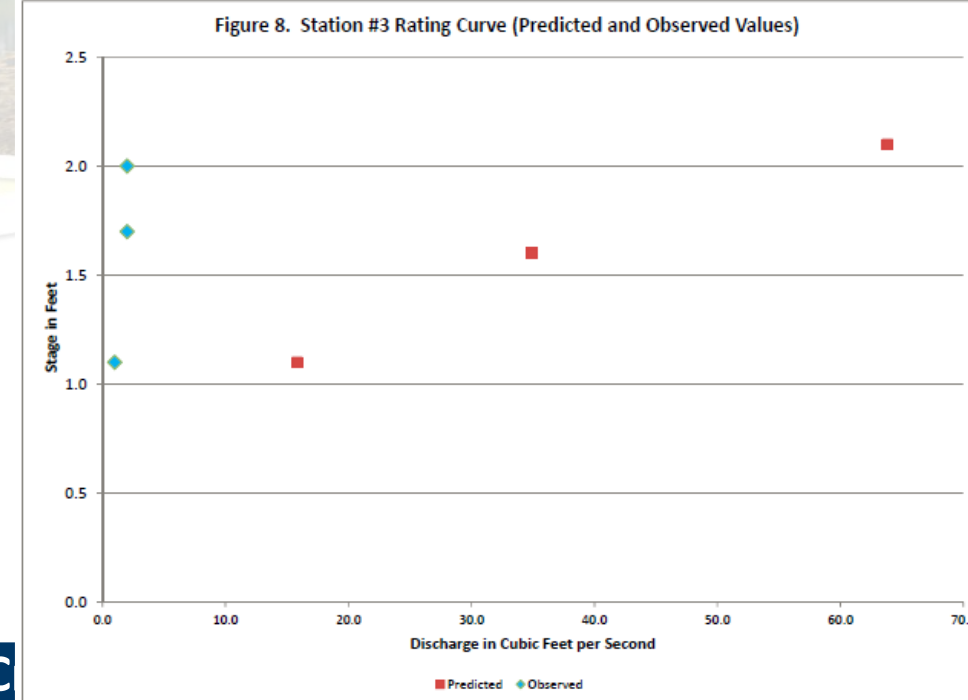
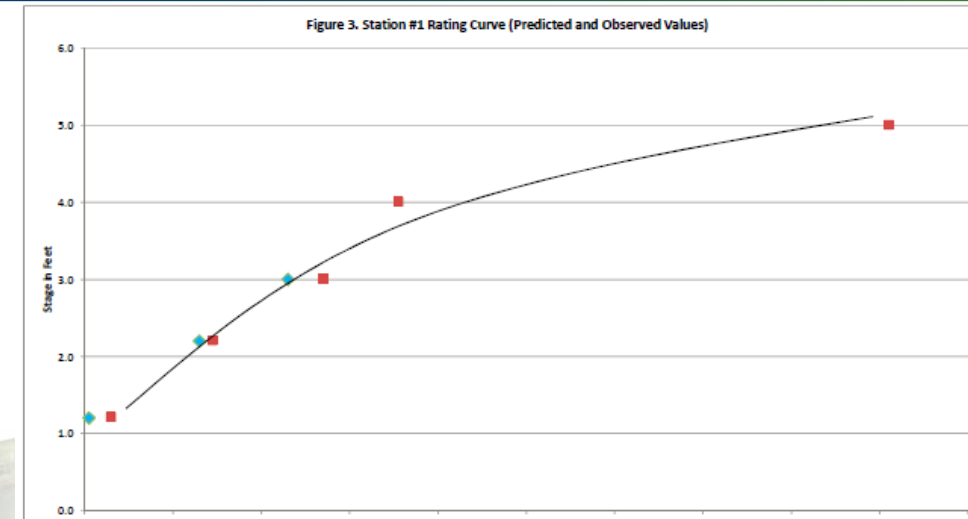

Mining and Post-Restoration Water Balance Analysis



- Complex water balance deals mostly with process water within mine operations
- Stormwater capture/recovery accounts for over 50% of the proposed mine water needs, this supply will reduce low flows in the New River
- Does not address land use/land cover changes and associated impacts to the basins hydrologic response

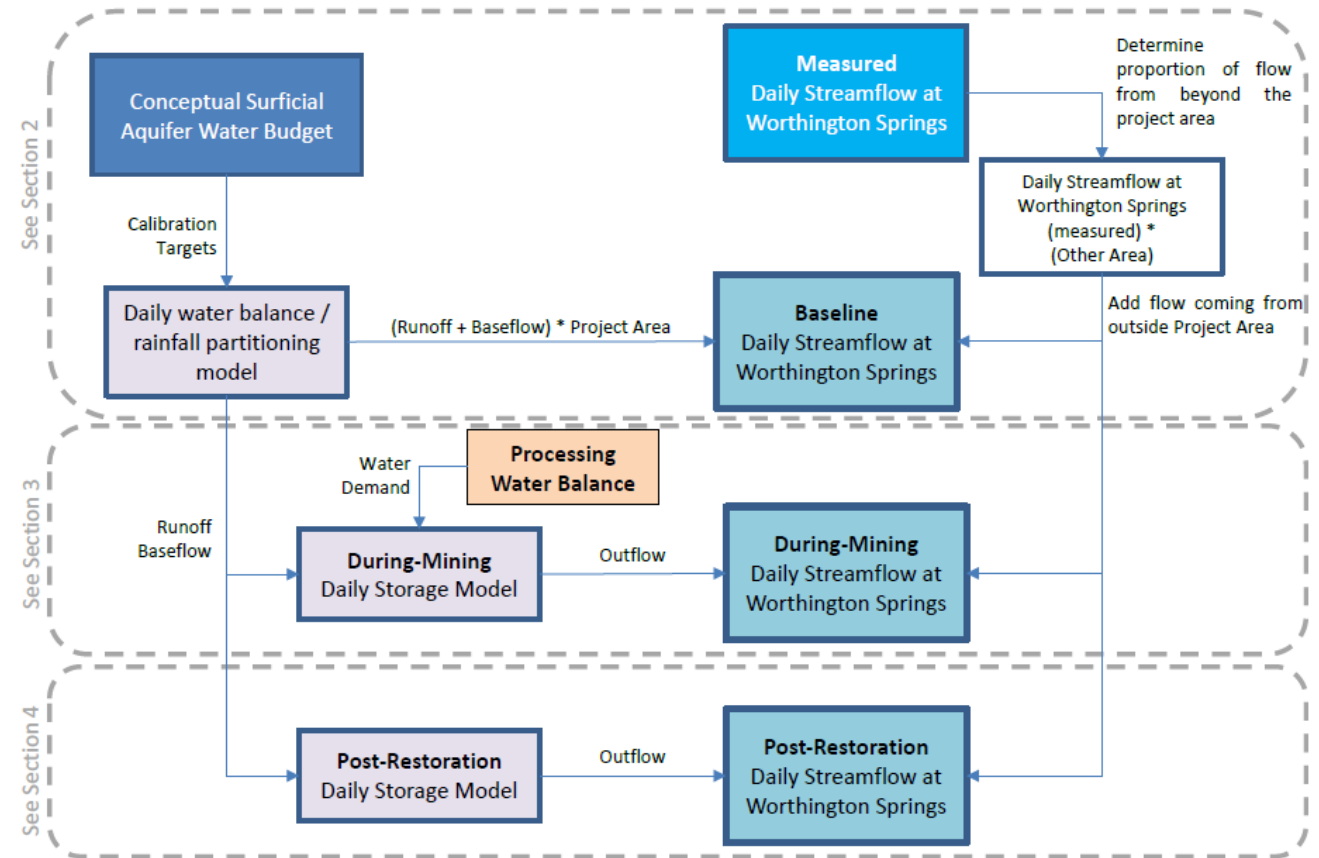
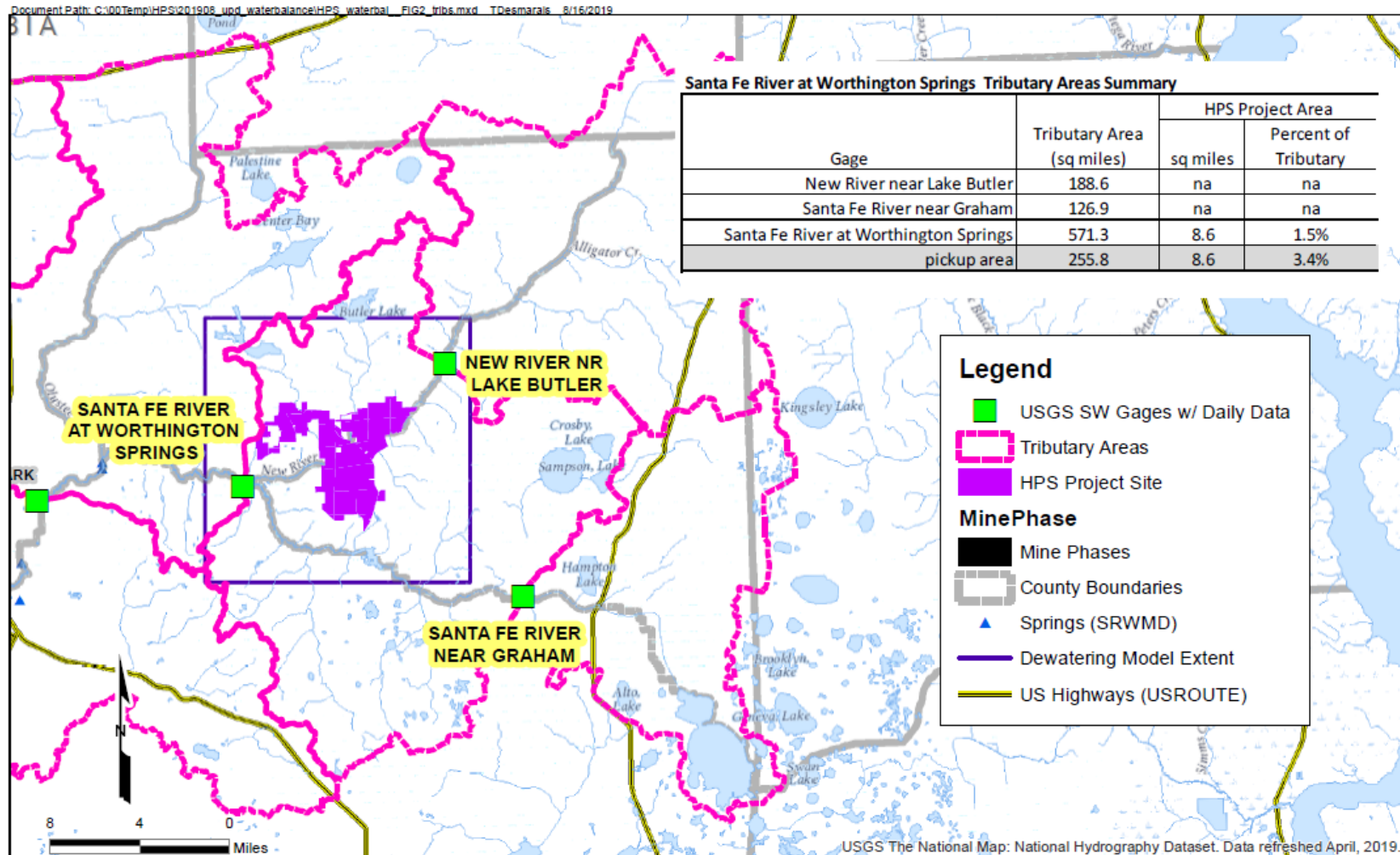

Figure 1 Water Balance Modeling Overview

Mining and Post-Restoration Water Balance Analysis



The information included on this graphic representation has been compiled from a variety of sources and is subject to change without notice. Kleinfelder makes no representations or warranties, express or implied, as to accuracy, completeness, timeliness, or rights to the use of such information. This document is not intended for use as a land survey product nor is it designed or intended as a construction design document. The use or misuse of the information contained on this graphic representation is at the sole risk of the party using or misusing the information.



PROJECT NO. 20163103.005A
 DRAWN: 2019.07.31
 DRAWN BY: TRD
 CHECKED BY: DJH
 FILE NAME:
 CUP_model_delineation.mxd

HPS Project Site and USGS Streamflow Gaging Stations

HPS Enterprises II, LLC
 SRWMD wup
 Bradford and Union Counties, Florida

FIGURE

2

ICPR4 Modeling – RAI Attachment 14

- ICPR4 groundwater model – to evaluate post-reclamation wetland suitability areas according to the expected wetland hydroperiod characteristics in the reclaimed wetlands
- Five proposed wetlands were planned in the study area
- The model was set up for a representative area in Bradford County.
- GW only Calibration – January 2016 – July 2017
- Full Simulation – January 1995 – December 2017

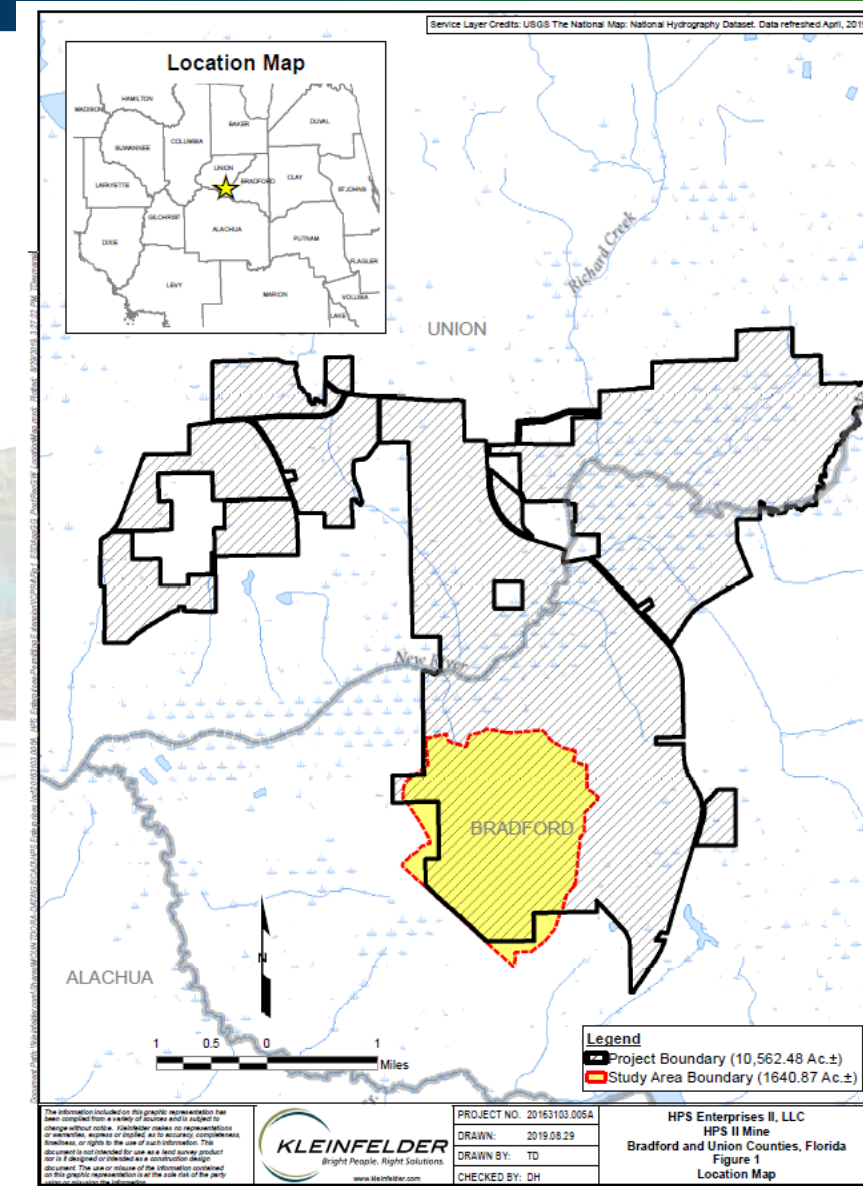

ICPR4 Modeling – Calibration GW only

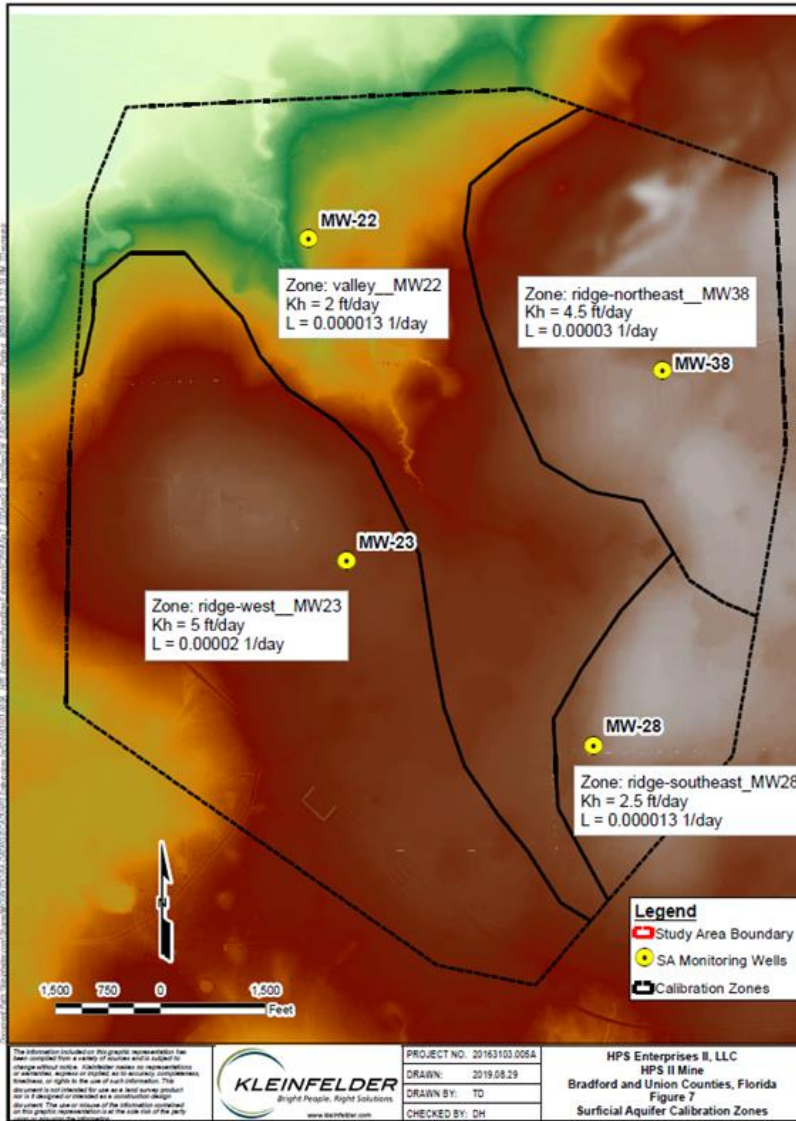

Model Calibration Summary

Calibration Statistics

Statistic	MW-22	MW-23	MW-38	MW-28
Residual Mean (feet)	0.32	0.00	-0.28	-0.37
RMSE (feet)	1.22	0.92	1.06	0.76

Modelwide Statistics

Scenario	Residual Mean (feet)	Residual Mean (feet)	Scaled RMS (percent)
Current	-0.08	-0.08	1.91%

Simulated Water Budget for Calibration Period

Rain	Water Budget (in/yr)		
	ET	UFA Rech	SW Discharge
47.1	34.2	6.2	7.7

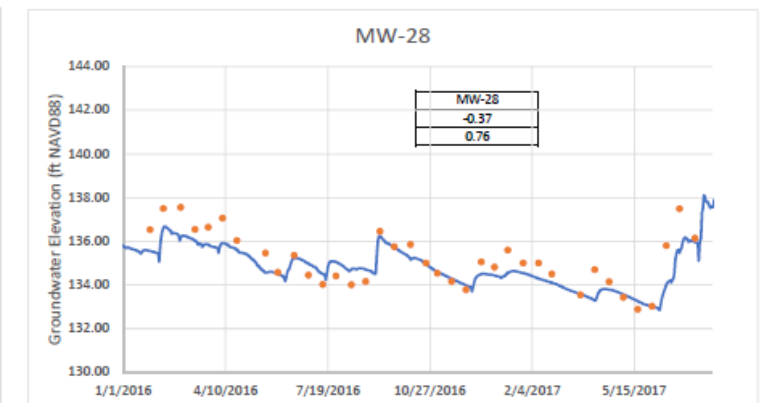
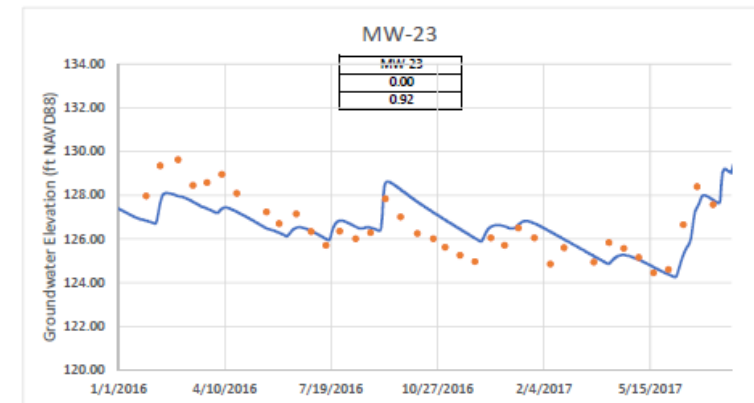
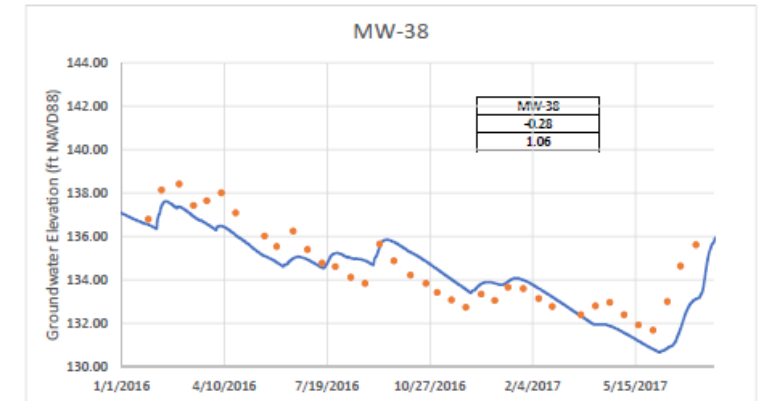
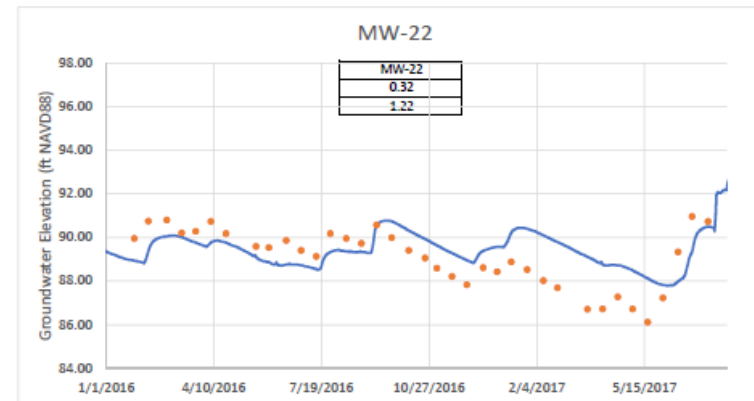

ICPR4 Modeling – Hydroperiod Analysis

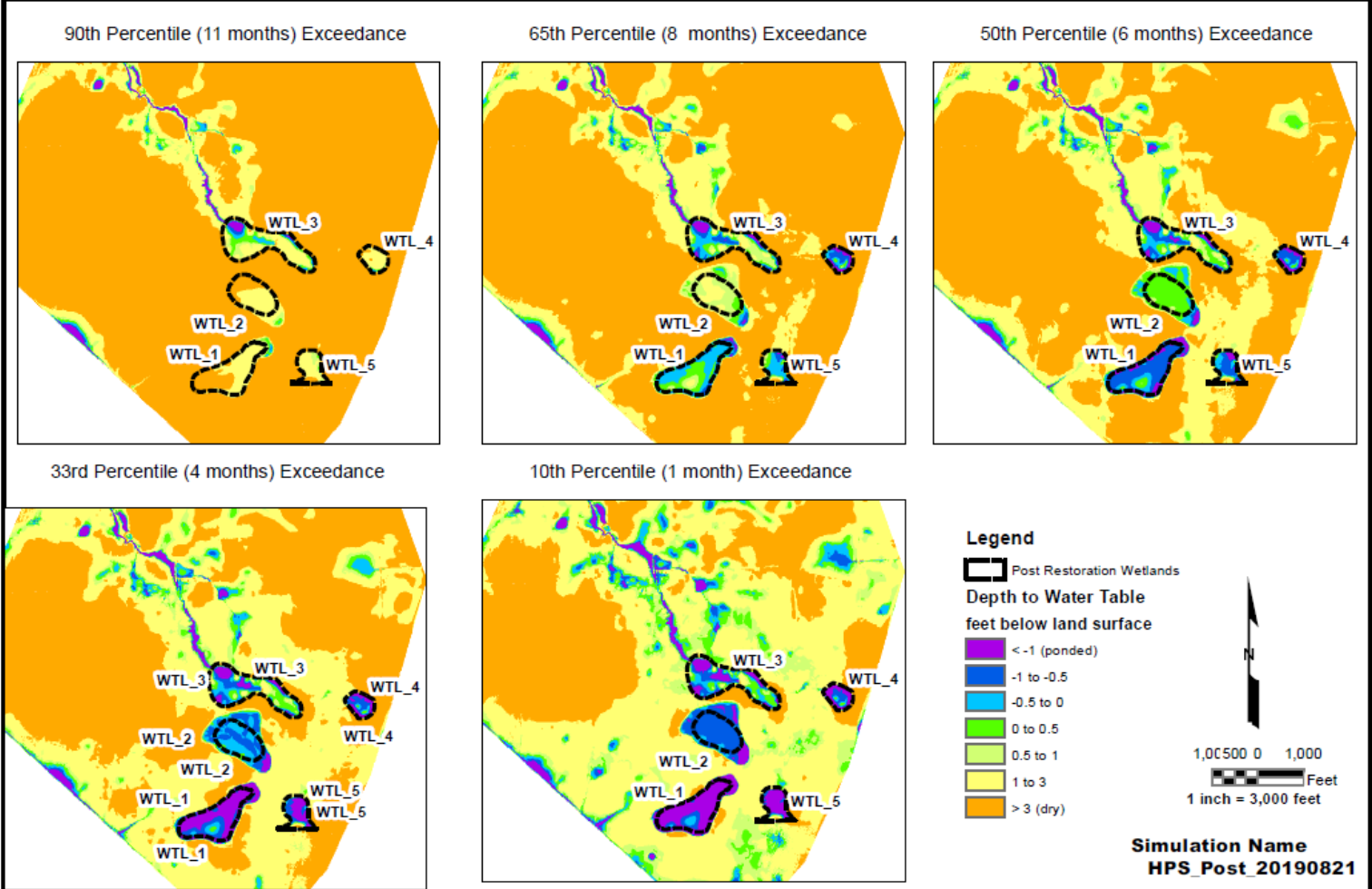
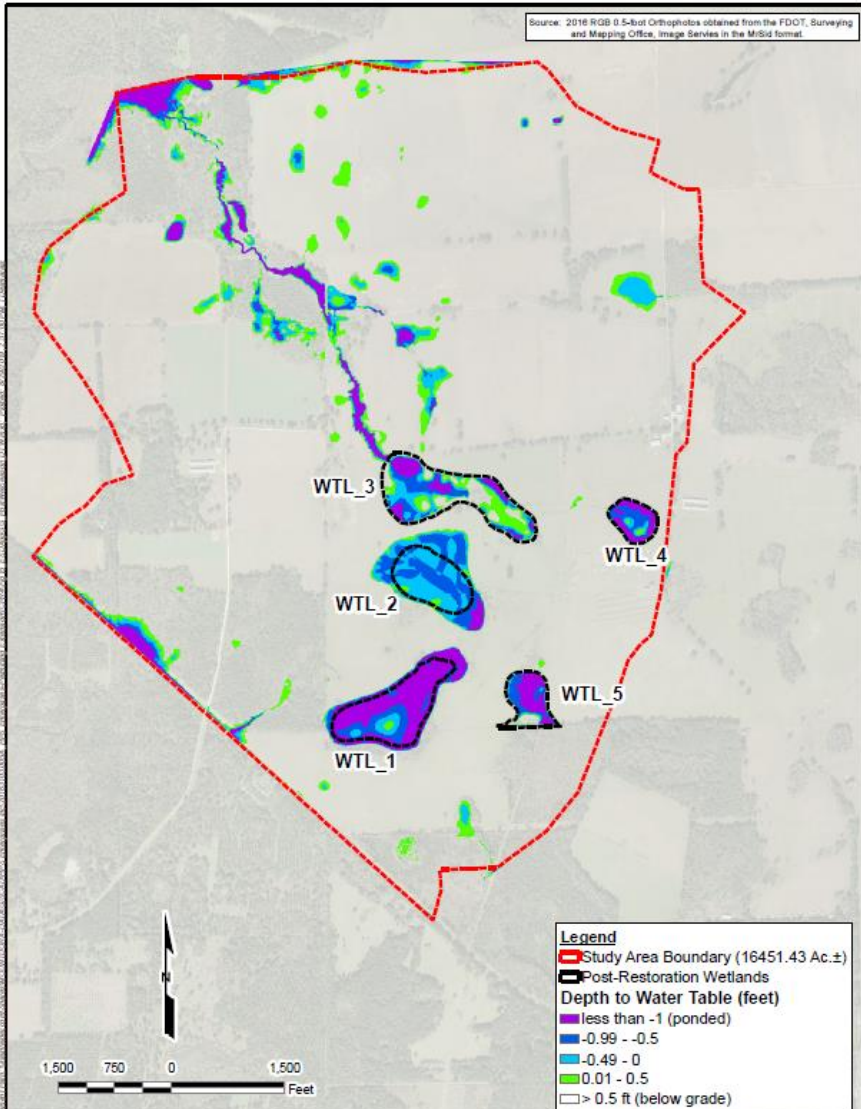

The information included on this graphic representation has been compiled from a variety of sources and is subject to change without notice. Kleinfelder makes no representations or warranties, express or implied, as to accuracy, completeness, timeliness, or rights to the use of such information. This document is not intended for use as a land survey product nor is it designed or intended as a construction design document. The use or misuse of the information contained on this graphic representation is at the sole risk of the party using or misusing the information.



PROJECT NO.	20163103.005A
DRAWN:	2019.08.29
DRAWN BY:	NCD
CHECKED BY:	TRD
FILE NAME:	HPS_post_20190821_gw_results.mxd

Post-Restoration Water Table Percent Exceedance
HPS Enterprises II, LLC HPS II Mine Bradford and Union Counties, Florida

FIGURE
C-3

Deficiency

- ICPR4 model is not mine wide
- No surface water calibration, therefore uncertainties exist in the predictive capability of surface water model and water balance
- Post-reclamation parameterization is not founded with observed sand clay properties
- Water balance addresses process water but not land use changes and consequent changes to hydrologic response

Pre- Post- Land Cover

- About 2 square miles of lakes will be created as part of the reclamation plan
- Lakes evaporate at or near Potential ET rates, **dramatically** reducing the water that could leave the site
- Event based modeling ignores ET losses, continuous modeling captures impacts from changing land use

Table 9: Pre-Mining and Post-Reclamation Land Uses- Bradford County

FLUCFCS	DESCRIPTION	Pre-Mining Acres	Post-Reclamation Acres
110	Residential, Low Density	68.75	7.78
205	Farm Structures	19.25	0.70
211	Improved Pastures	1,977.31	1,882.35
213	Woodland Pastures	17.66	7.60
214	Row Crops	447.83	48.84
232	Poultry Feeding Operations	3.16	0.0
420	Upland Hardwood Forests	5.10	2.15
427	Live Oak	2.27	0.08
434	Hardwood - Conifer Mixed	175.62	447.24
441	Coniferous Plantations	261.71	93.11
442	Hardwood Plantations	4.74	2.08
511	Natural Streams	10.17	22.87
512	Ditched Natural Streams	4.62	0.07
513	Wetland Cut Ditch	4.61	1.86
514	Upland Cut Ditch	10.47	1.10
520	Lakes	0.0	527.48
525	Wetland Cut Cattle Pond	4.81	1.29
526	Upland Cut Cattle Pond	4.87	0.06
527	Upland Cut Lakes less than 10 acres	6.60	0.64
610	Wetland Hardwood Forests	122.79	123.55
613	Gum Swamps	3.65	3.68
615	Stream and Lake Swamps (Bottomland)	1,484.05	1,476.63
621	Cypress	20.71	21.55
629	Coniferous Plantation, Hydric	33.31	22.94
630	Wetland Forested Mixed	283.98	285.12
640	Vegetated Non-Forest Wetlands	196.23	197.59
641	Freshwater Marshes	5.62	3.76
643	Wet Prairies	10.97	10.62
812	Railroads	1.45	0.35
832	Electrical Power Transmission Lines	2.10	1.35
Totals		5,194.44	5,194.44

Table 10: Pre-Mining and Post-Reclamation Land Uses- Union County

FLUCFCS	DESCRIPTION	Pre-Mining Acres	Post-Reclamation Acres
110	Residential, Low Density	4.97	3.76
205	Farm Structures	51.95	6.85
211	Improved Pastures	897.92	1,487.43
213	Woodland Pastures	141.27	46.51
223	Other Groves	9.97	0.0
410	Upland Coniferous Forests	23.49	10.26
420	Upland Hardwood Forests	94.36	40.73
427	Live Oak	11.19	4.66
434	Hardwood - Conifer Mixed	421.82	684.46
441	Coniferous Plantations	1,587.97	337.44
442	Hardwood Plantations	27.72	8.46
511	Natural Streams	16.99	26.94
512	Ditched Natural Streams	6.72	0.22
513	Wetland Cut Ditch	0.75	0.10
514	Upland Cut Ditch	15.49	3.02
520	Lakes	0.0	646.01
525	Wetland Cut Cattle Pond	0.22	0.15
526	Upland Cut Cattle Pond	7.29	1.46
609	Logged Wetland Hardwoods	294.64	20.01
610	Wetland Hardwood Forests	310.84	584.78
611	Bay Swamps	4.99	5.05
613	Gum Swamps	2.72	3.72
615	Stream and Lake Swamps (Bottomland)	1,052.83	1,050.42
621	Cypress	17.79	17.59
629	Coniferous Plantation, Hydric	209.30	59.76
630	Wetland Forested Mixed	239.94	403
631	Wetland Scrub	3.77	4.12
640	Vegetated Non-Forest Wetlands	115.25	114.21
641	Freshwater Marshes	50.05	51.91
643	Wet Prairies	12.98	13.34
743	Spoil Areas	2.43	0.0
8145	Graded and Drained Road	3.45	1.02
Total		5,641.07	5,641.07

Pre-Mining Land Cover

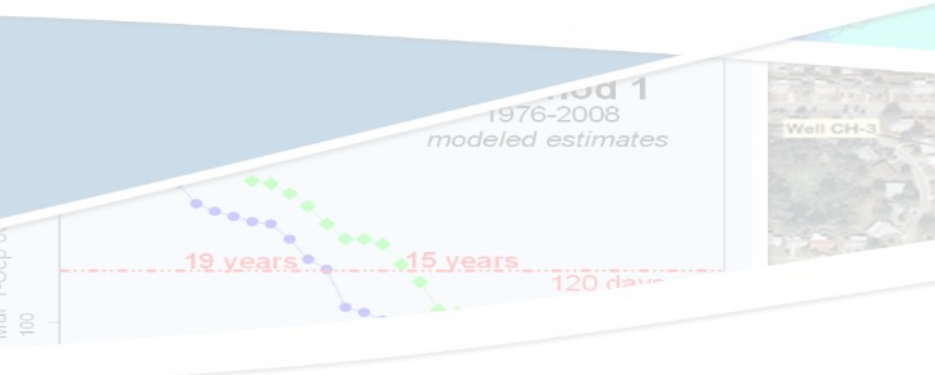
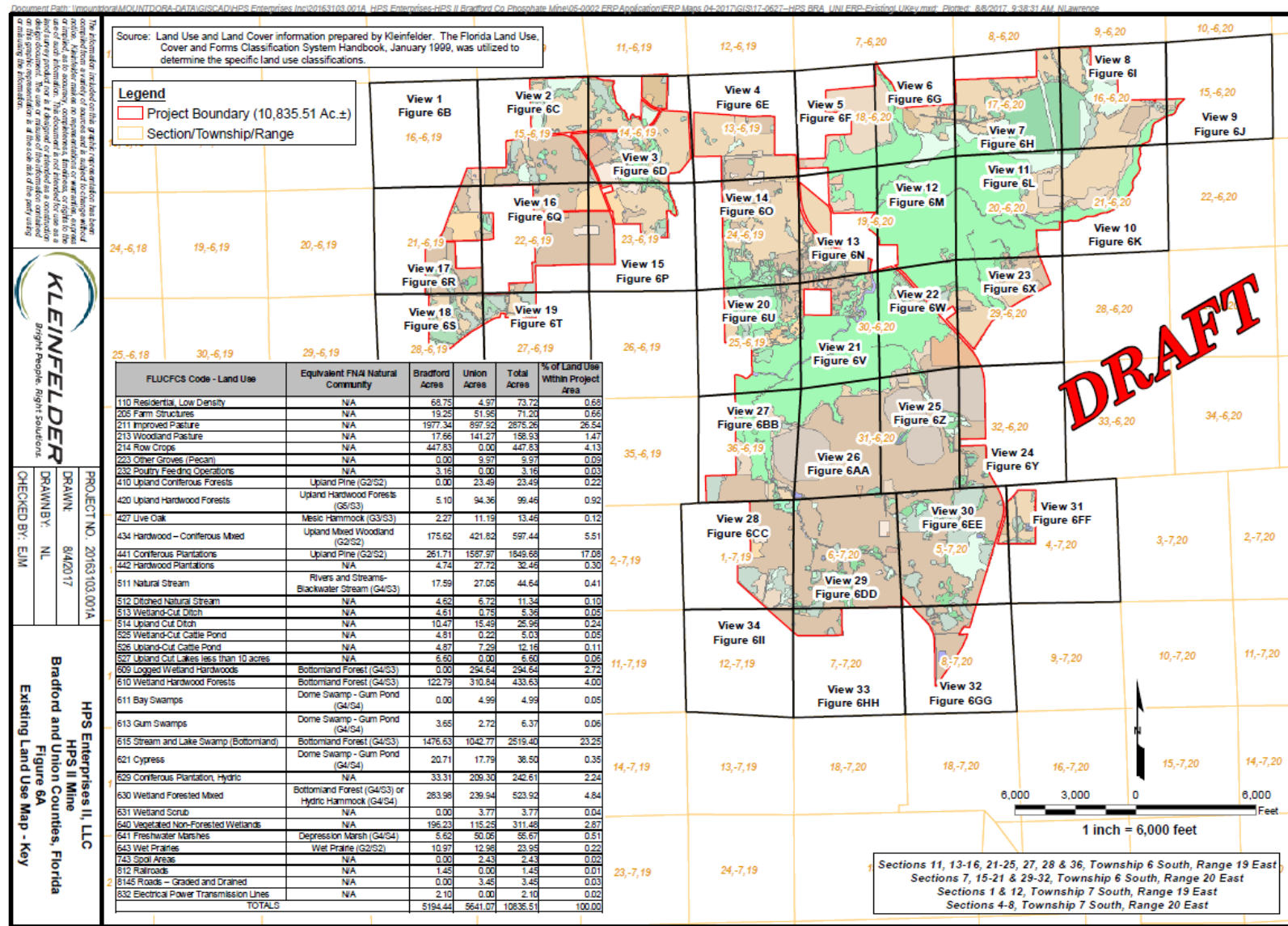

Post-Reclamation Land Cover

- Note the large lake areas in the reclamation plan

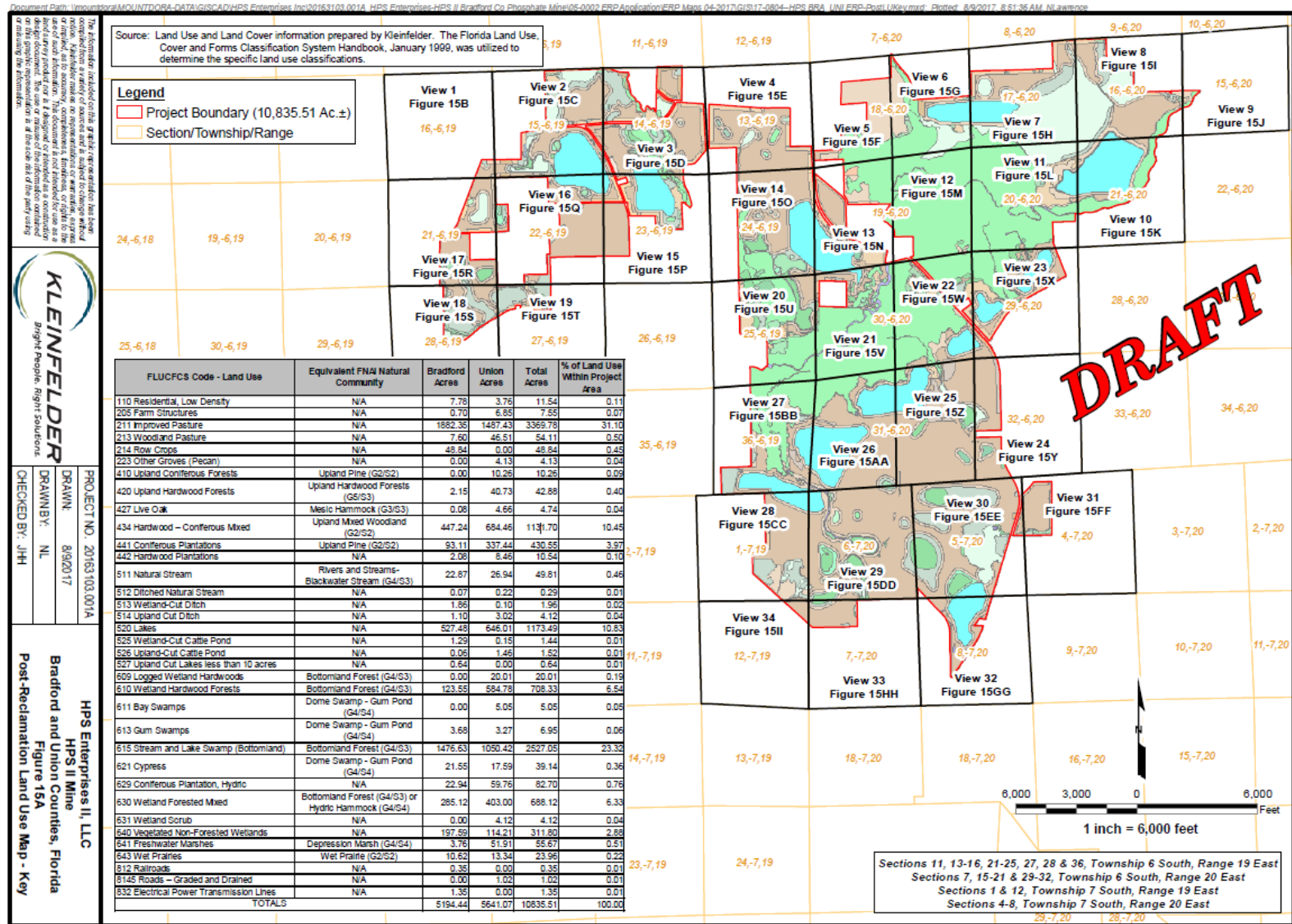
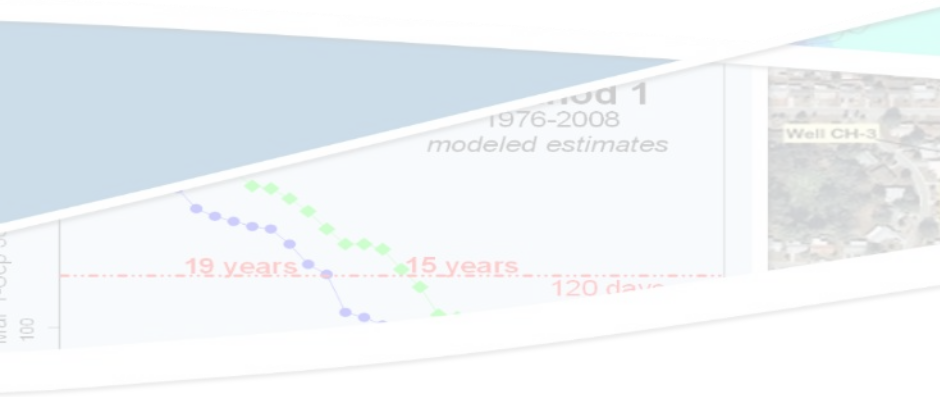

Ground Water

- Develop **Mine wide GW model**
 - Appropriate boundary conditions
 - Incorporate active mine (dewatering)
 - Incorporate reclaimed mine
 - At least incorporate surficial, intermediate and Floridan layers
- Proposed consumptive use and water level changes
 - How will mine water consumption and water level changes affect Upper Santa Fe MFL
- Hydraulic properties (pre/post)
- GW model should be based on NFSEG (model co-developed by SRWMD and SJRWMD to evaluate MFLs)

Ground Water – MODFLOW Model

MODFLOW model was setup to demonstrate the drawdown associated with dewatering activity.

Groundwater modeling was performed to:

- (a) demonstrate that the proposed dewatering necessary to extract the material (approximately 35' deep) will not induce drawdown to avoided wetlands and other sensitive areas; and
- (b) estimate surplus water that will be available from dewatering.

Since the project will proceed in phases, and each phase has its own unique physical settings and geometric configuration, a groundwater (GW) model was prepared that utilizes the typical mining/dewatering schematic layout developed for this project. In terms of estimating available surplus water quantities, the model was set up conservatively, assuming an avoided wetland is adjacent to two sides of the dewatered area. The model simulates the first three months of a new site's dewatering, with the first month being closest to the theoretical wetland area.

The model results demonstrate that drawdown associated with the dewatering activity can be managed in a manner that will not adversely affect nearby avoided wetlands. With the correct configuration and amount of flow returned, a groundwater mound will develop in the area surrounding the recharge ditch. Thus, actively managing the flow to the recharge trench will allow the operation to create a drawdown in uplands and areas not proposed for avoidance, which will yield additional water in most situations.

Linked SW/GW Models

- The New River contributes to 40% of flow to Upper Santa Fe River, and significantly impacts the Upper Santa Fe River MFL
- Any hydrologic impact analysis would have to be very detailed
- As previously mentioned, continuous modeling is required
- The hydrologic analysis will have to incorporate some degree of integration between the surface water system (rainfall/runoff) and the groundwater system (recharge/baseflow)

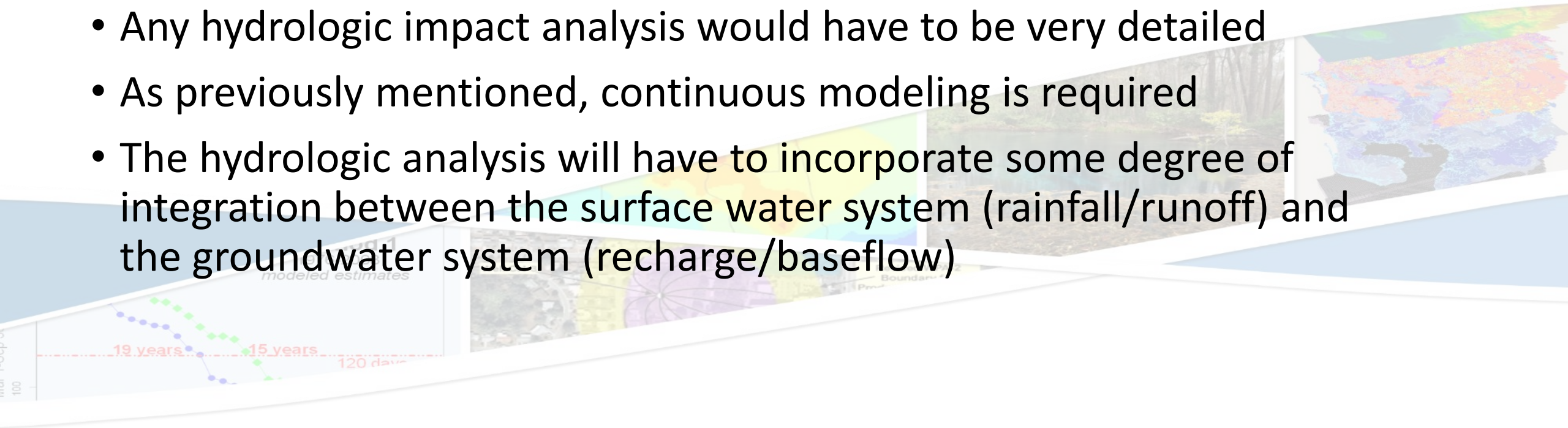

Field Data

- Stream Flows are available from the USGS upstream of the mine
- Stream flows should be monitored from now till x years after mine reclamation downstream of the mine
- Water levels
- Aquifer performance testing
- Local climatological data

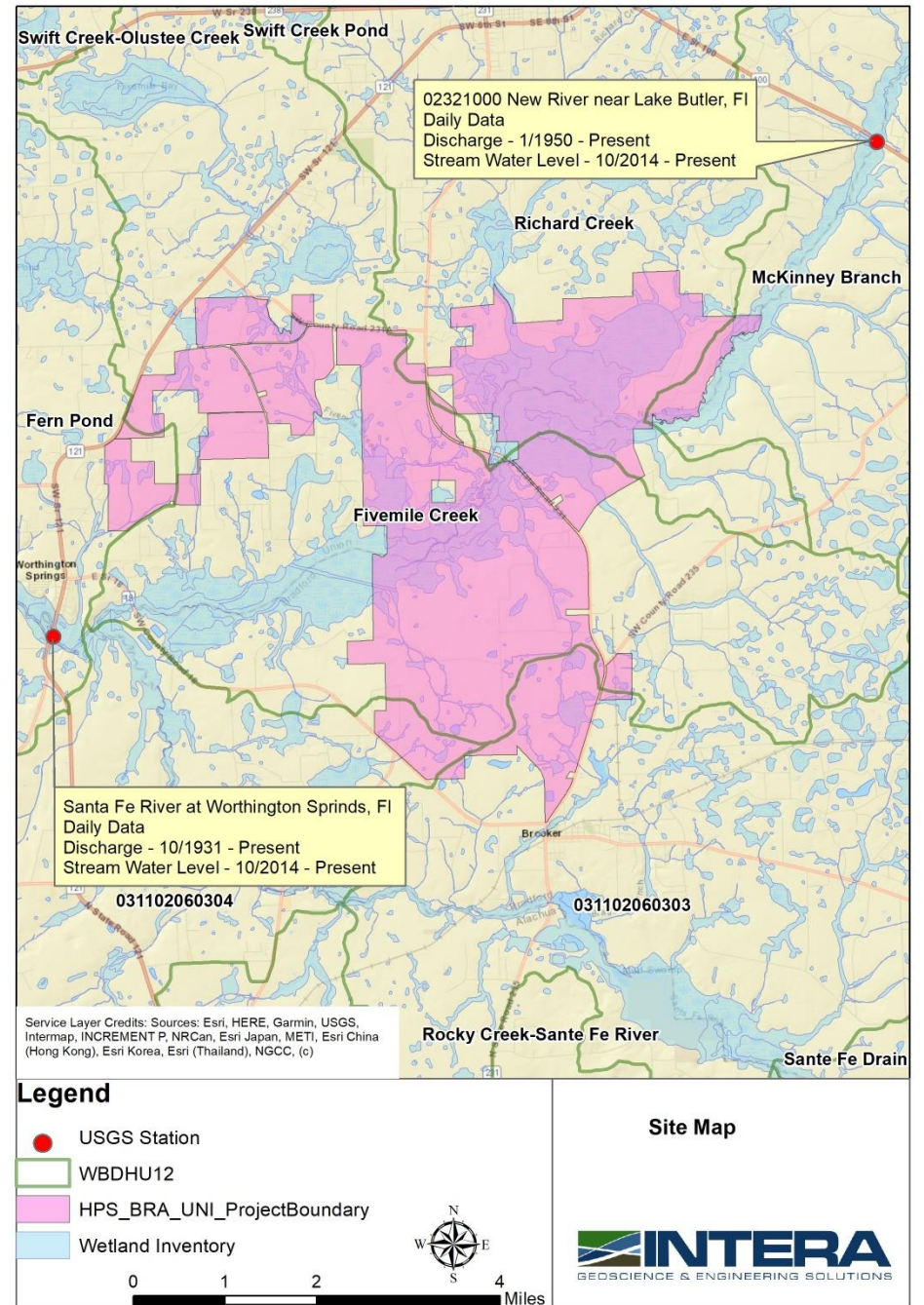

Domestic Wells

- Impacts to domestic self supply must be analyzed
- Water quantity
- Water quality

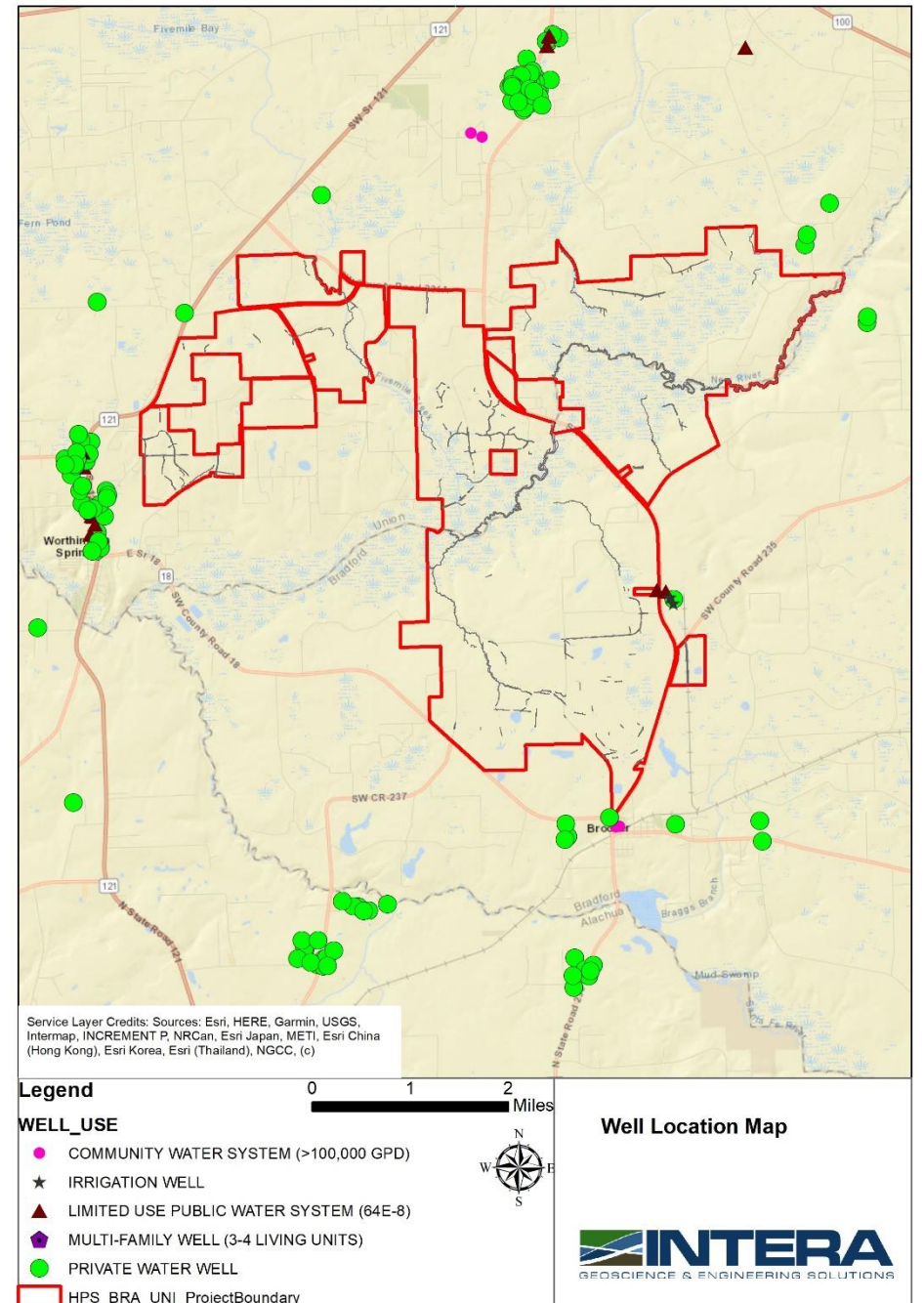
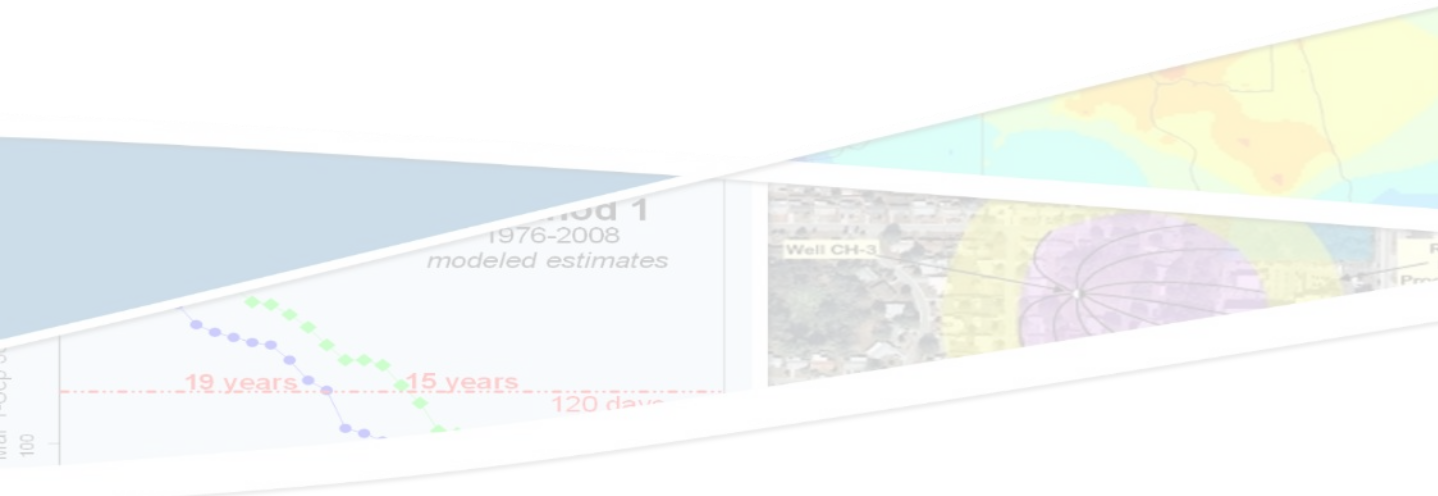

Mine Reclamation Concerns

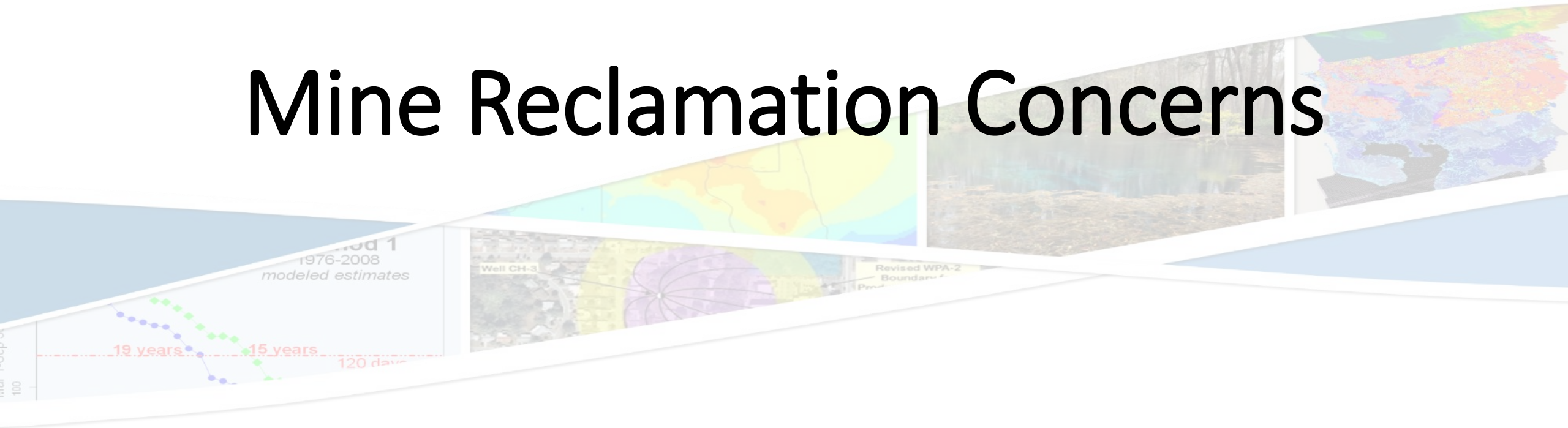

Mine Reclamation

- HSP II is proposing a new reclamation method that involves mixing of clay wastes with sand
- The method has been tested using rehydrated clay wastes from the Central Florida Phosphate District
- Pilot study was small in size, and recommendations for further testing was made in FIPR report
- The composition (mineralogy and mineral proportions) of clays varies from North to South in Florida
- There were limited tests using local clays. Sampling and testings protocols are problematic. Demonstrations that the process can be scaled up to mine-sized operations are needed

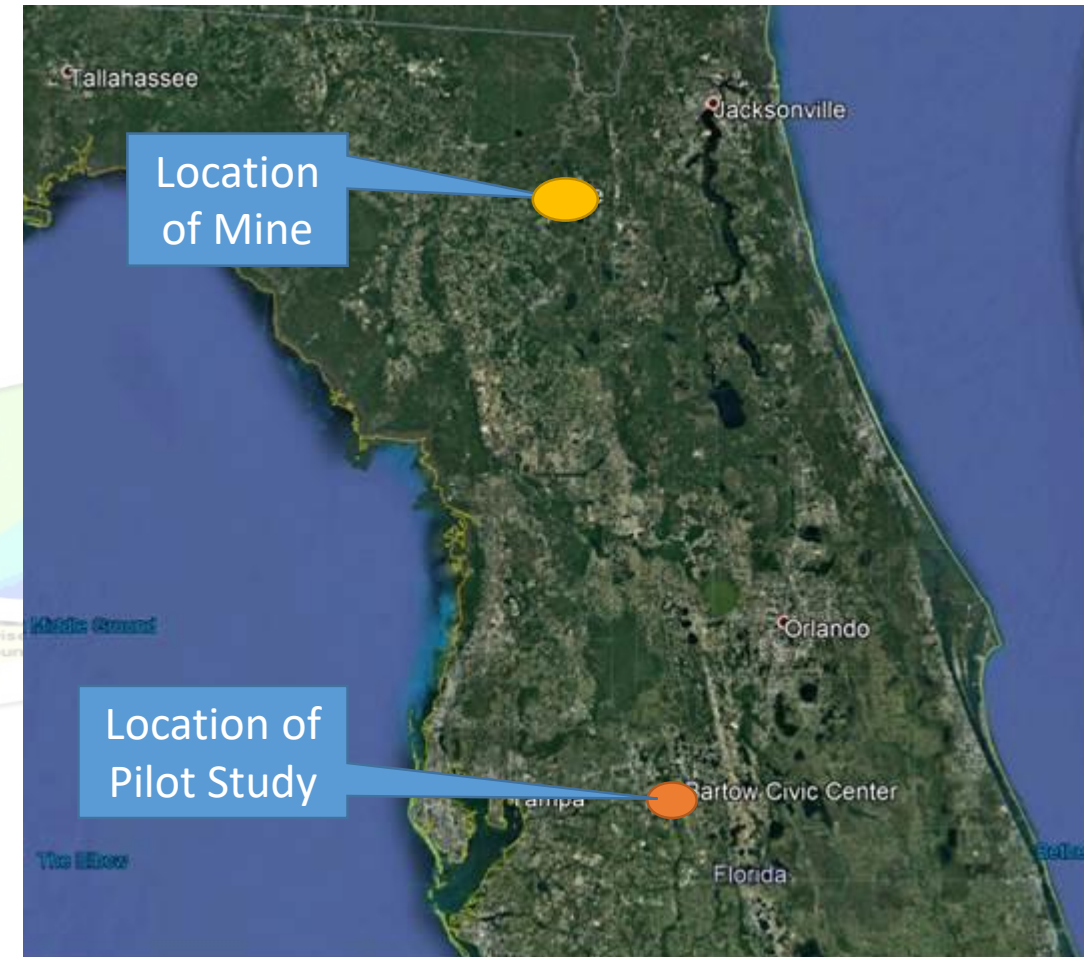

FIPR Study - Recommendation

Pilot Plant Demonstration of Sand-Clay-Overburden Mix for Accelerated Reclamation , 2017

RECOMMENDATIONS

Technical personnel from the Florida phosphate industry that visited the pilot plant, commented with their observations and concerns. A common comment was that additional pilot testing at a beneficiation plant site with freshly produced clay slurry would be prudent to confirm the pilot test results obtained using rehydrated clay slurry. The pilot plant utilized rehydrated clay slurry instead of freshly produced clay slurry to avoid problems encountered by one or more of the previous clay rapid dewatering projects. The solids content of clay slurry produced on day shift frequently fluctuates due to operating upsets caused by maintenance downtime and/or pit moves.

The project team agrees with the above comment and recommends additional testing of the piloted process at a beneficiation plant site using freshly produced clay slurry and flotation tailings. It is proposed that the pilot plant operation would be during day shift; however, it is strongly recommended that the clay slurry collection should be during second or third shift when fewer operating disruptions occur. The accumulated clay slurry would be sampled and then fed to the pilot plant.

Sand/Clay Flocculent Mix

- Infiltration rates for reclaimed sand/clay mix
- Vertical and horizontal hydraulic conductivity
- Migration of clays after placement
 - Precipitation
 - Wind
 - Newly placed material will be highly susceptible to erosion and re-distribution
- Fate and transport of polymer flocculent

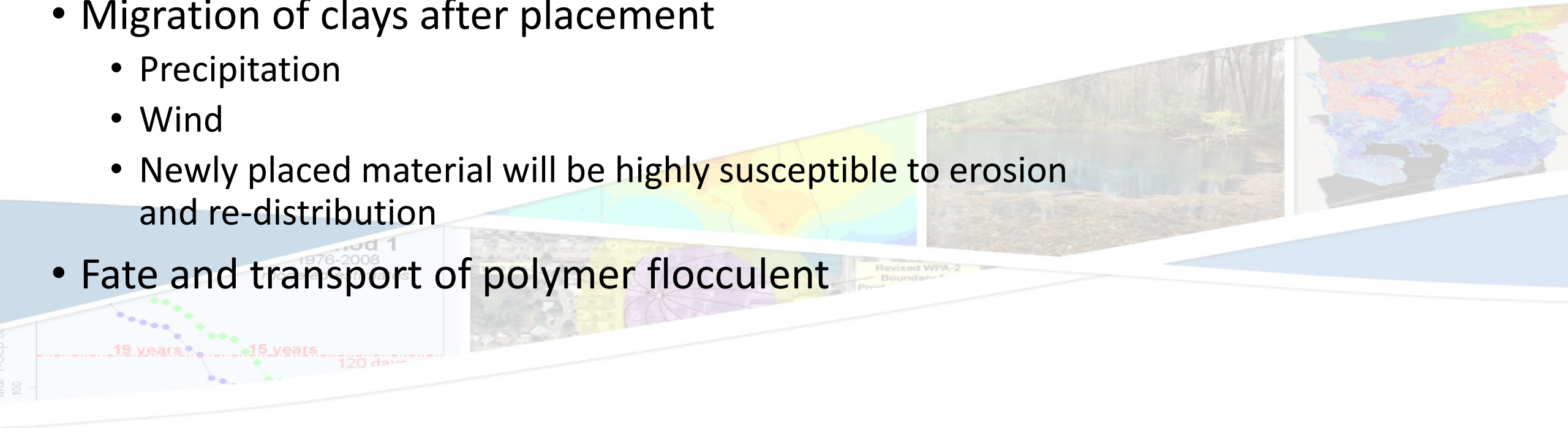

Conveyor Transport

- Impacts at river crossing
- Loses from conveyor
 - Conveyor is enclosed with “spill proof floor”
 - Precipitation
 - Wind
- Long term success
 - Conveyors are proven in arid climates
 - Humid environment may cause additional complications
- What is plan B if conveyor transport is not successful?

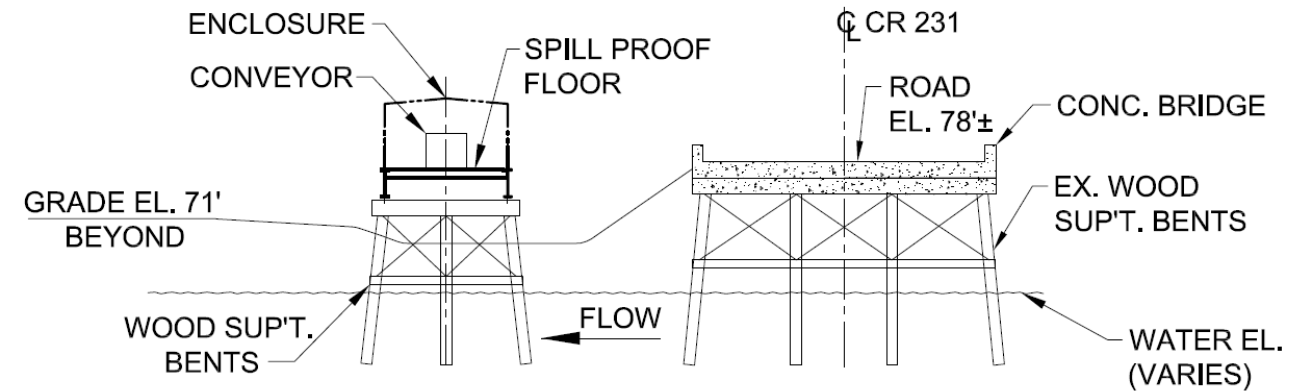

Conveyor Crossing Plan

- Hydraulic impacts at river crossing
- The many piers in the channel will cause additional erosion
- The conveyor crossing is extended towards an area where the principle axis of the river more north-south
- Additional debris accumulation possible

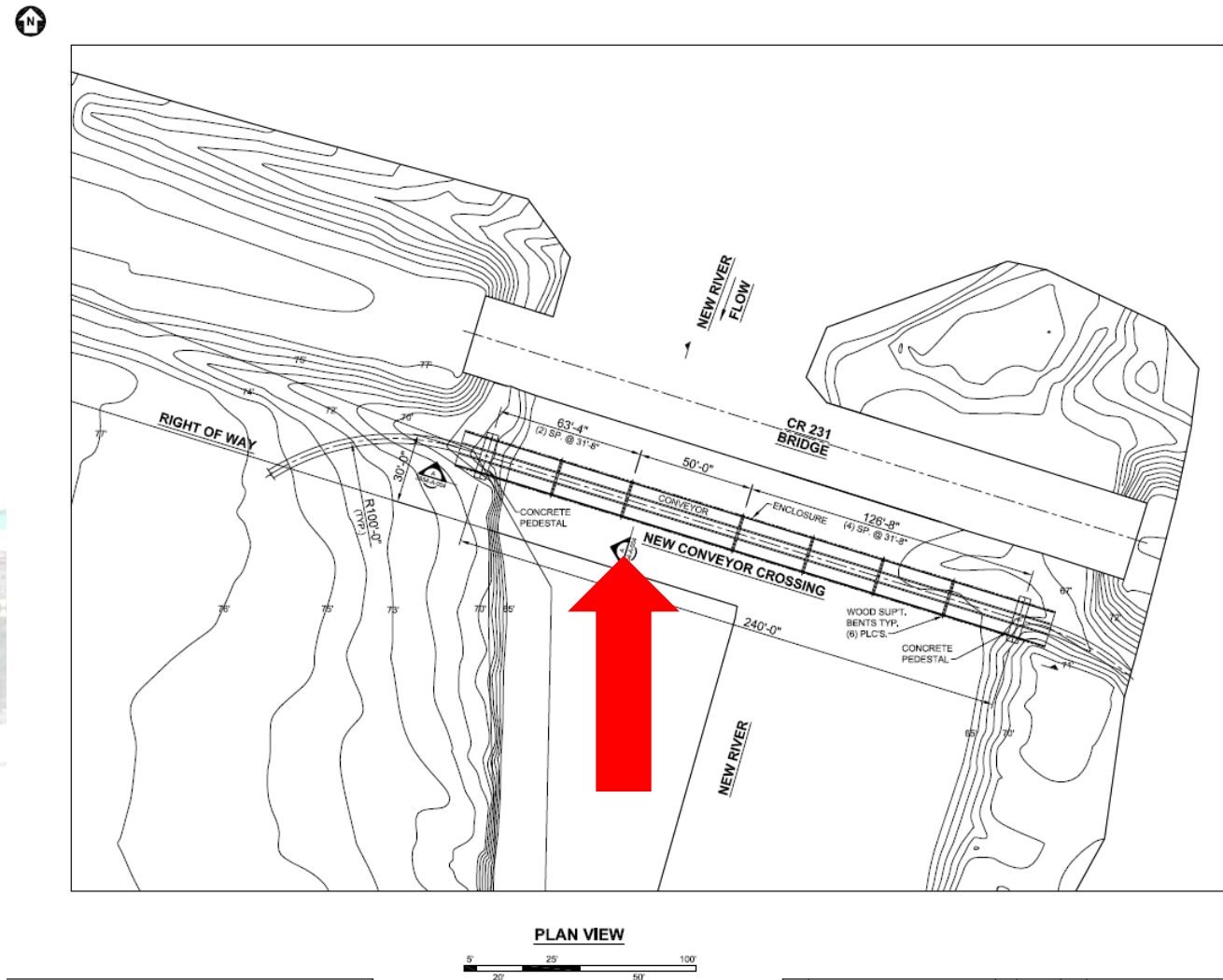

PRELIMINARY
NOT FOR FABRICATION
OR CONSTRUCTION

WORK THIS DWG. WITH DWG. 3854-A-004

CASE ENGINEERING, INC.
2215 SOUTH FLORIDA AVE.
LAKELAND, FLORIDA 33803
PROFESSIONAL ENGINEER DAVID L. NEDERVELD
PROFESSIONAL LICENSE NUMBER 16620

CASE ENGINEERING
WILBERY, FLORIDA
CERTIFICATE OF AUTHORIZATION #16, 2019

HPS MINING
HPS II, LLC, BROOKER, FL.
NEW RIVER CROSSING
PLAN

Conveyor Crossing Plans

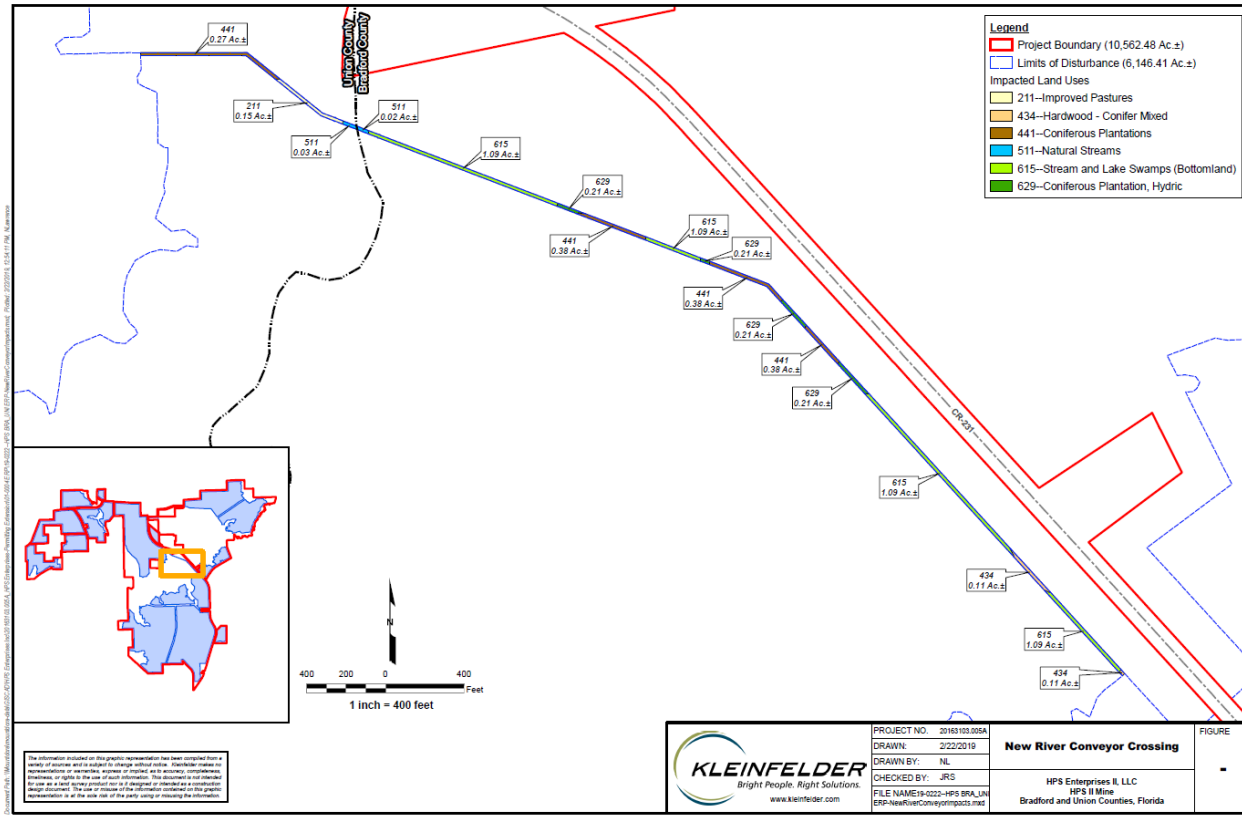
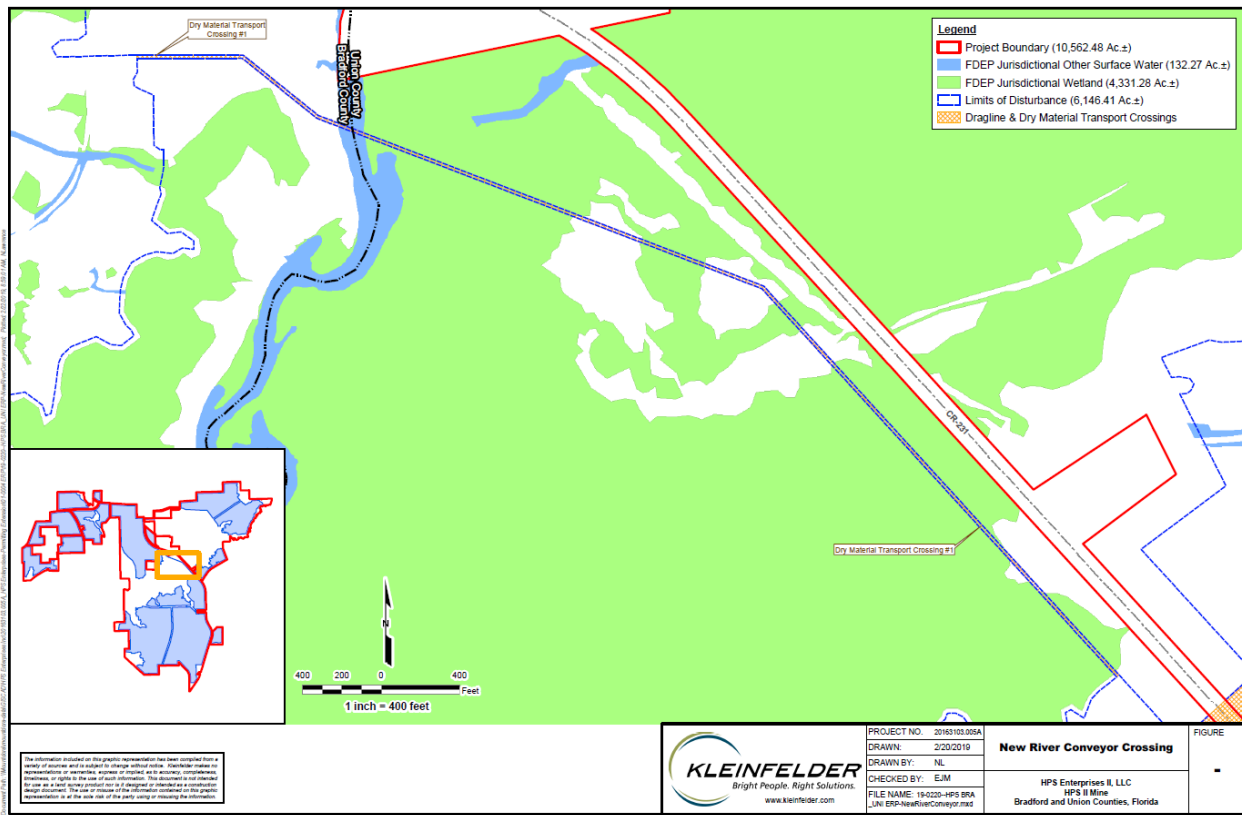

Hydrogeological Concerns

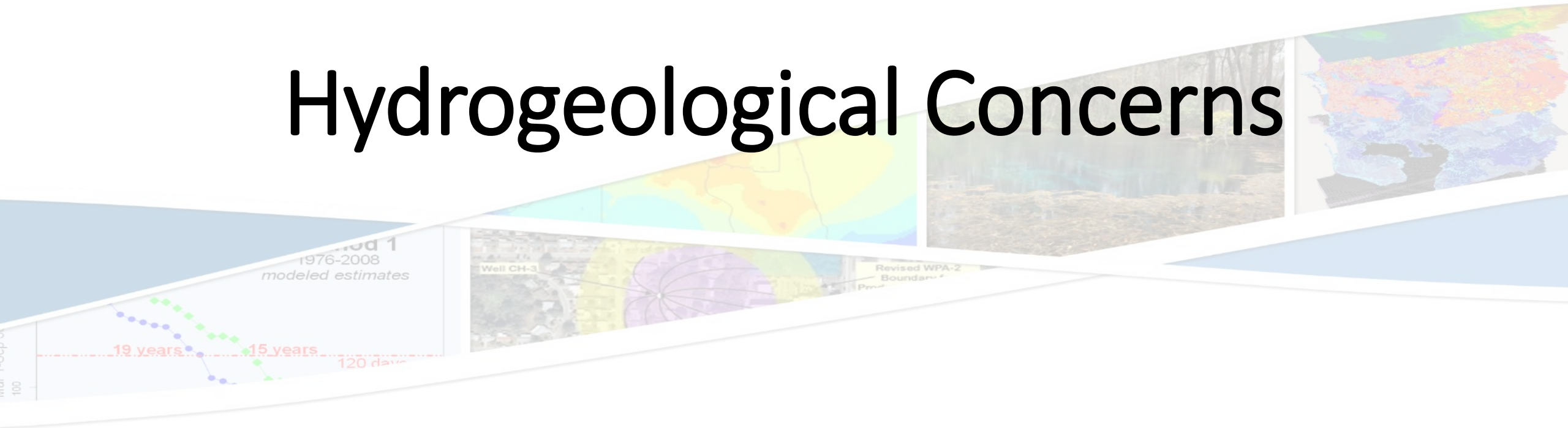

Springs

- Springshed representations in HSP II's presentation are problematic
- Loss of recharge or flow in the New River may have adverse affects on spring flow (MFL concern) and water quality, especially at a 2nd magnitude spring upstream from the River Sink
- Impacts on the Upper Floridan Aquifer by loss of recharge and/or consumptive use may impact the Santa Fe River Rise and nearby springs
- A more accurate and detailed analysis of potential impacts on springs is needed

Springs

- Upchurch created most of the springshed delineations
- Floridan aquifer potentiometric data in Upper Santa Fe Basin was inadequate
- Unclear who drew springsheds near HPSII mine area

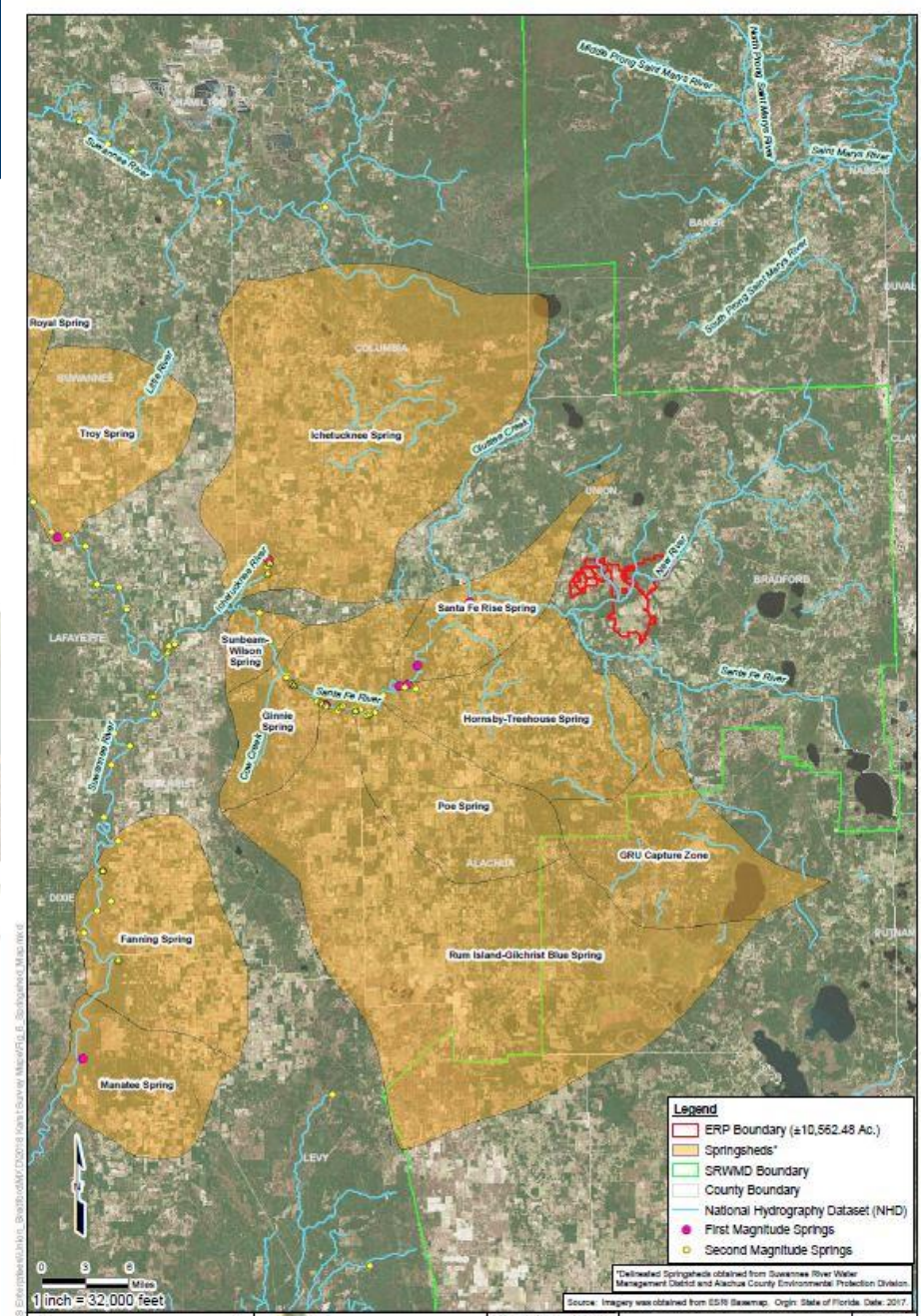

Springs

- Regional data suggest that any mining effects on the Upper Floridan Aquifer are likely to affect
 - River Rise and Old Bellamy Cave discharge
 - Treehouse/Hornsby Springs discharge

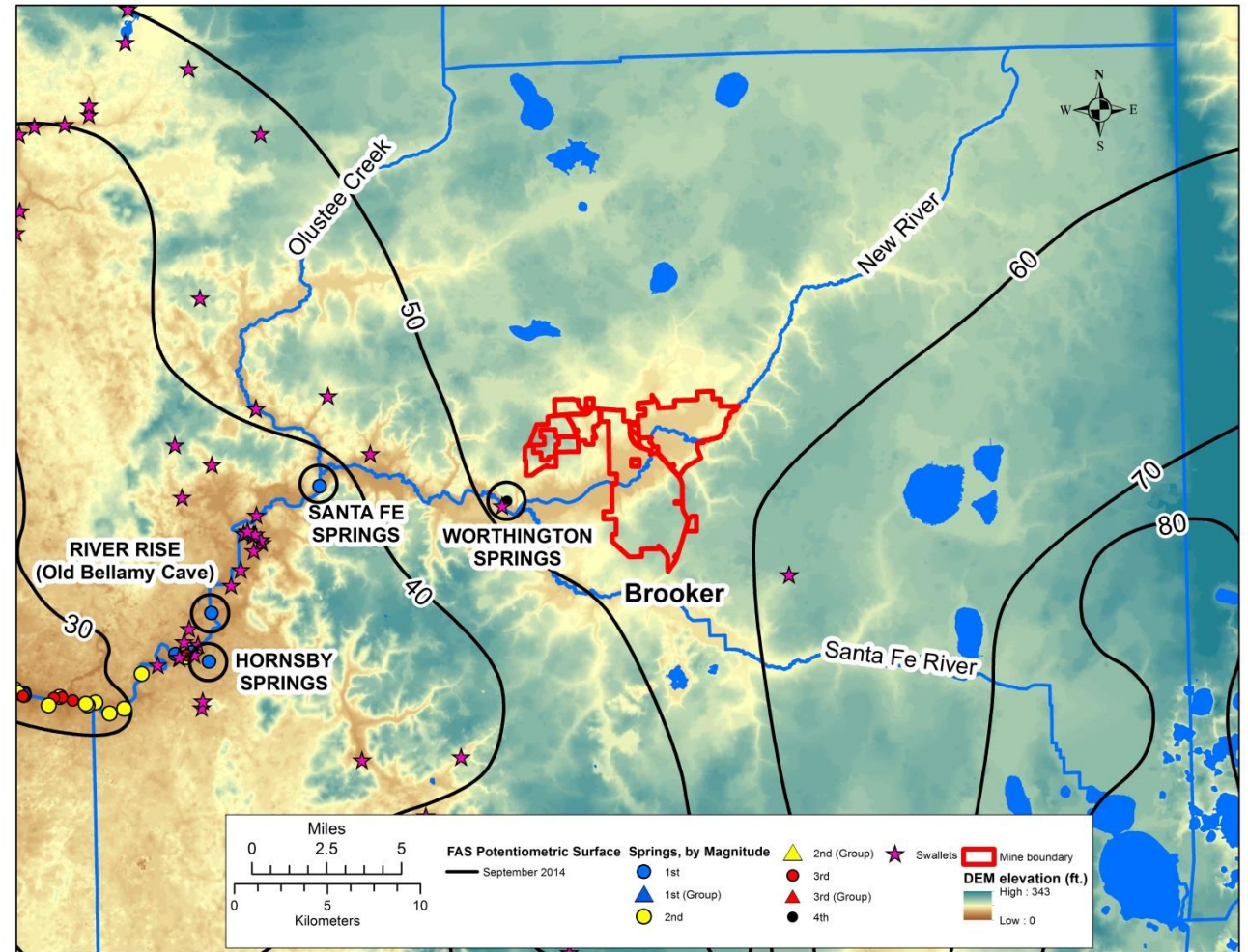
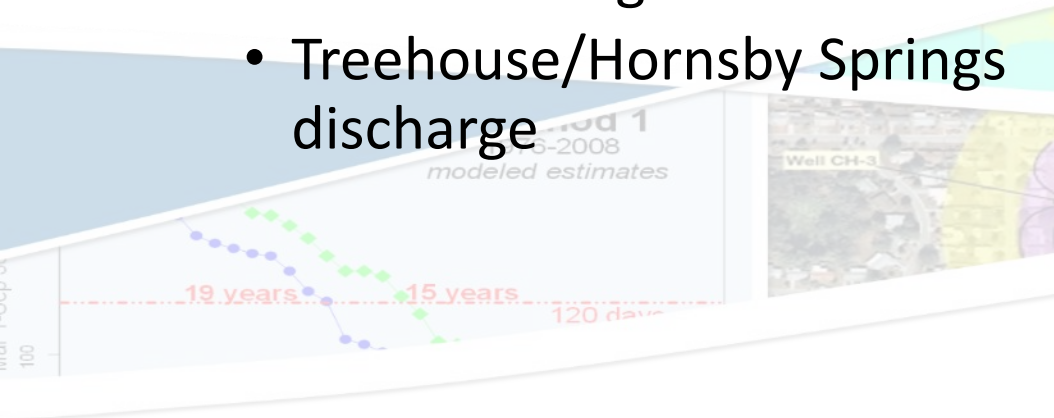

Springs

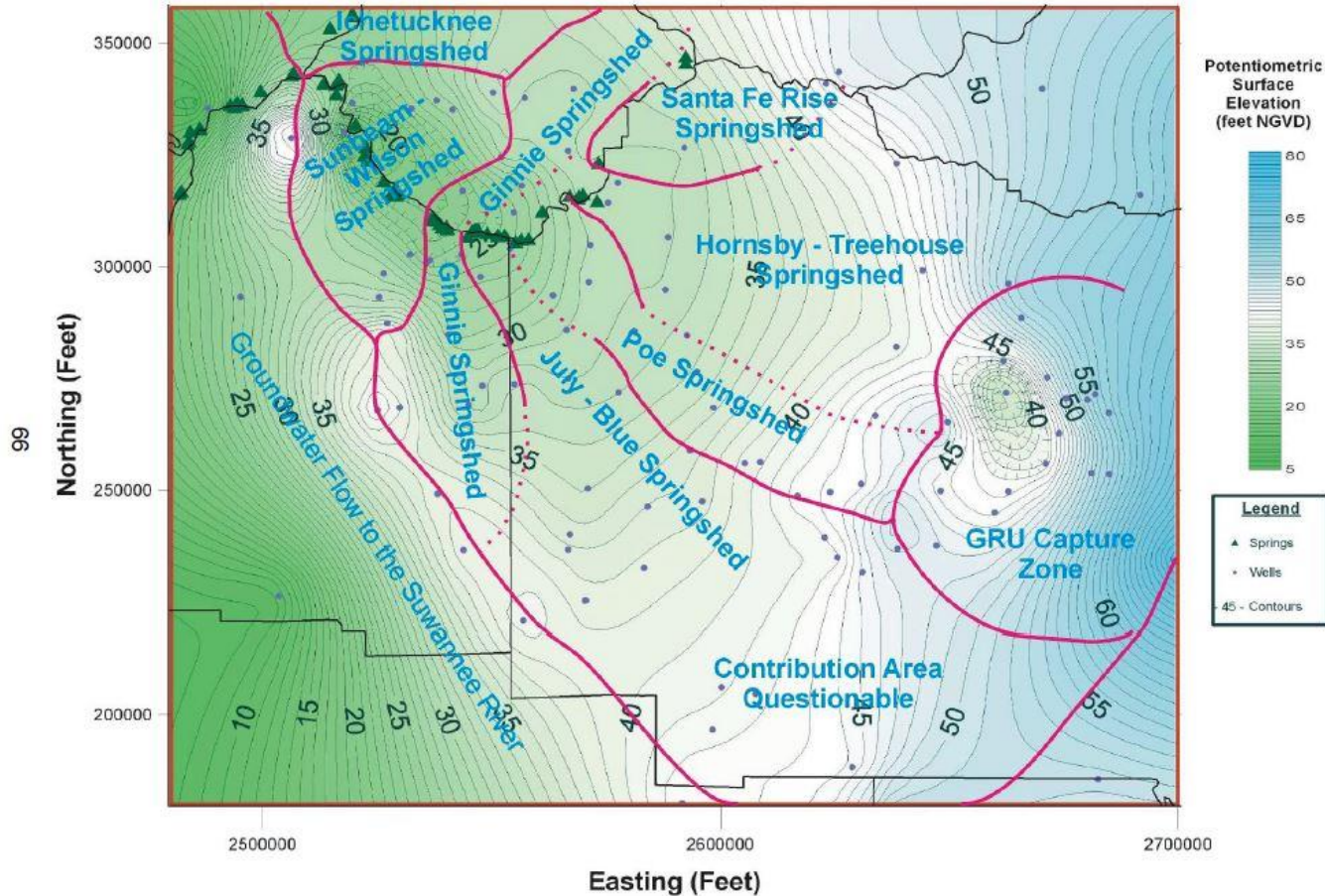

Figure 17 – Springsheds in the vicinity of the Newberry Plain delineated on the basis of the high-resolution potentiometric surface data.

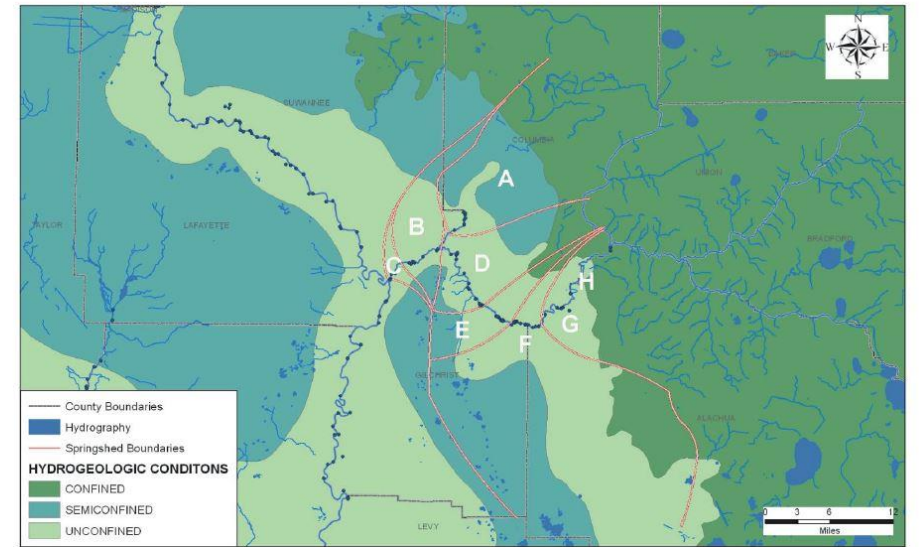

Figure 8 - Springsheds drawn from the 2000 potentiometric surface modified as discussed in the text. Springsheds were terminated at the point where the upper Floridan aquifer becomes well confined. Springsheds are as follows: A. Ichetucknee Springs Group, B. Betty Spring cluster (north), C. Betty Spring cluster (south), D. Sunbeam and Wilson Spring clusters, E. Ginnie Springs cluster, F. Poe-Rum Island Springs cluster, G. Hornsby-Columbia Springs cluster, and H. Santa Fe Rise.

There isn't enough data to accurately delineate the springsheds of Worthington Spring, Treehouse/Hornsby springs, or the unnamed 2nd magnitude springs upstream from the River Sink

Upchurch et al. (2008) springshed delineations

Hydrogeological Characterization

- Ignores most of previous work on area
- Potential **regional** effects not addressed
 - Karst
 - Effects on the Intermediate and Upper Floridan Aquifers
 - Assumption that HPSII will only affect the Surficial Aquifer
- May have erred in
 - Identifying the top of the Intermediate Aquifer and Confining System
 - Placement of the “matrix” (phosphatic ore) in the Surficial Aquifer
 - Characterization of sediments in what HPSII calls the Surficial Aquifer

Surficial / Intermediate Aquifer Boundary

- HPSII argues that they are mining the Surficial Aquifer sediments
- There is a mine-wide clay bed at about 10-15 feet below land surface
 - 87% of monitoring well logs report the clay
 - Matrix (phosphatic ore) is at 12 to 40 feet below land surface according to monitoring well logs, so matrix is below the clay
 - Most well logs presented in HPSII application stop at the clay, so good information as to what lies below is lacking
- Conventional geologic mapping would place matrix in the Coosawhatchie Formation (Hawthorn Group)

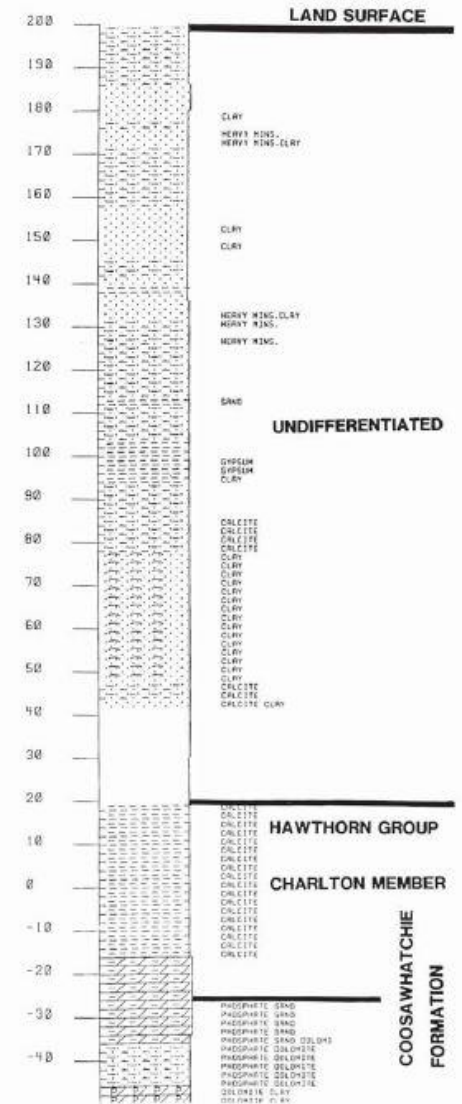

Charlton Member of the Coosawhatchie Formation

- Limestone and dolostone stratum at the top of the Hawthorn Group and just below surficial sands
- “At Brooks Sink, Bradford County, about 26 feet of sandy dolomitic coquina with scarce phosphate pellets are exposed above typical phosphatic dolomite of the Hawthorn formation.” (Espenshade and Spencer, 1963, p. 27)
- Importance of the Charlton –
 - Local aquifer within the Intermediate Aquifer System and Confining Beds
 - Source of water to Worthington Springs
 - Probable water-supply aquifer for local users
 - Karst features

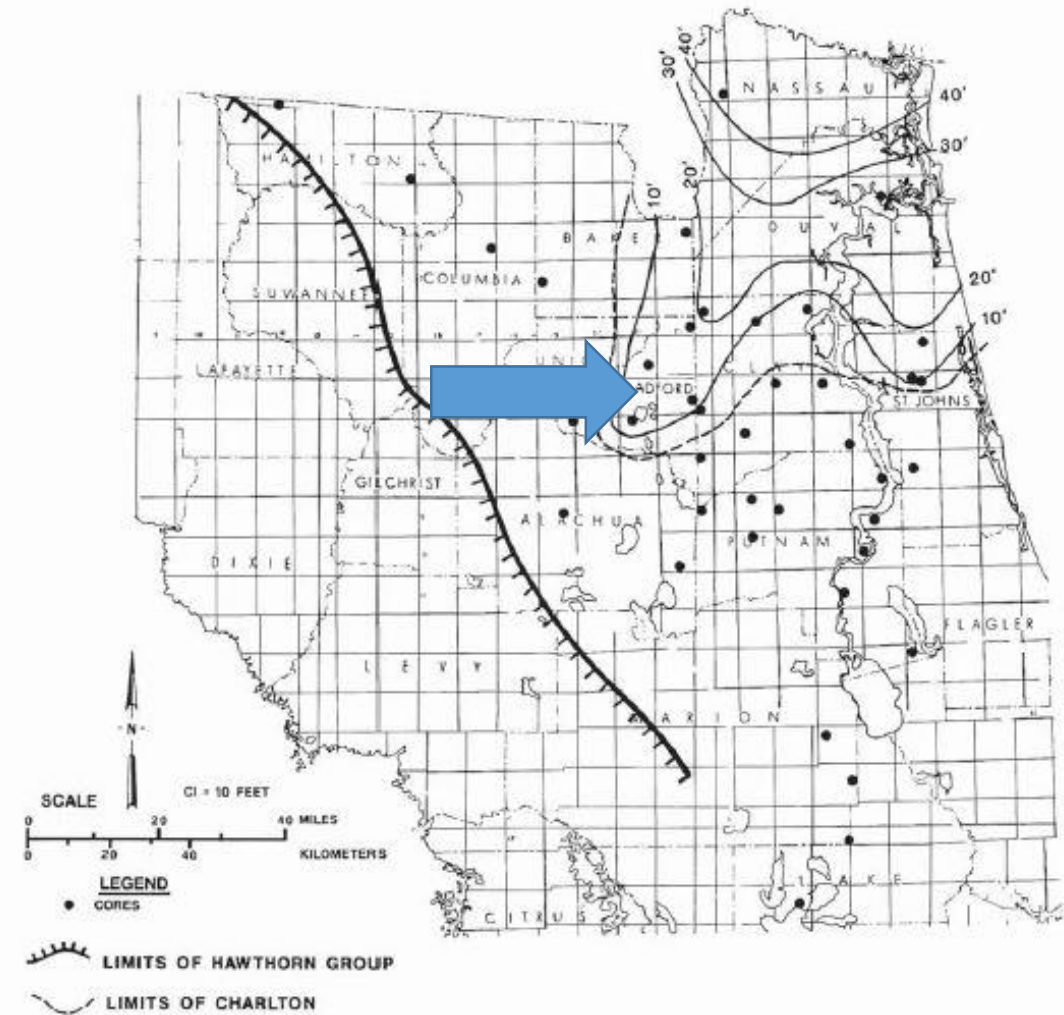

Figure 29. Isopach of the Charlton Member (dashed line indicates extent of Charlton).

Aquifer and Water Use

- Unknown number of wells tapping the Surficial, Intermediate, and Upper Floridan aquifer systems
 - Brooker
 - Lake Butler
 - Neighbors
- Need an inventory of domestic and public wells, including aquifer(s) tapped within the areas affected by mining
- Water supply to non-mining interests, such as residents of Brooker, is a concern
- There are concerns about the Charlton Member of the Coosawhatchie Formation (Hawthorn Group)
 - Serves as an aquifer east of the Santa Fe Basin
 - Appears to be the source of water at Worthington Springs
 - ***HPS II appears to be planning to mine through the Charlton in order to get to the ore***

Uncertainty Regarding Reclamation Materials Behavior

- We know that there are textural, mineralogical, and stratigraphic differences between the phosphate deposits of north and central Florida
- Tests to verify reclamation method used central Florida clay
- We have no guarantees that the method will be cost-effective in north Florida

The Strata Have Different Names and, Most Likely, Different Clay to Sand Proportions and Clay Mineralogy

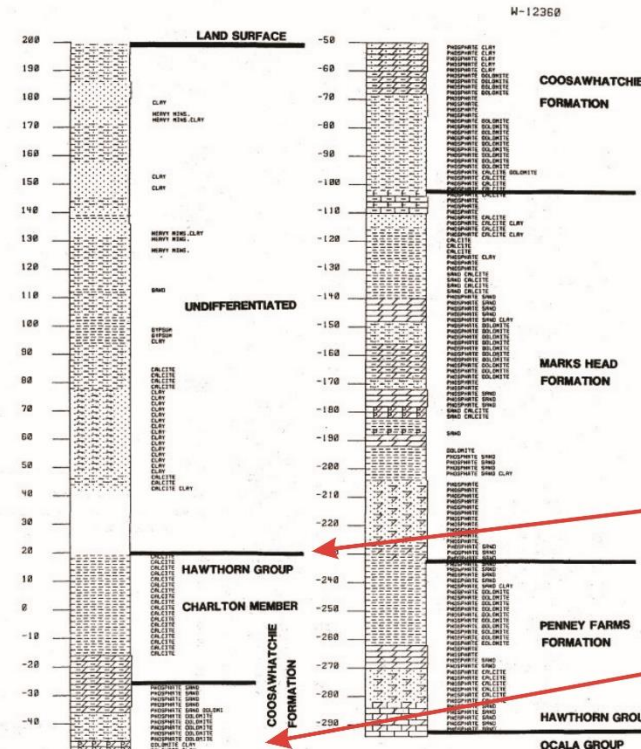

Figure 21. Reference section for the Marks Head Formation, N.L. #1, W-12360, Bradford County (Lithologic legend Appendix A).

BRADFORD COUNTY

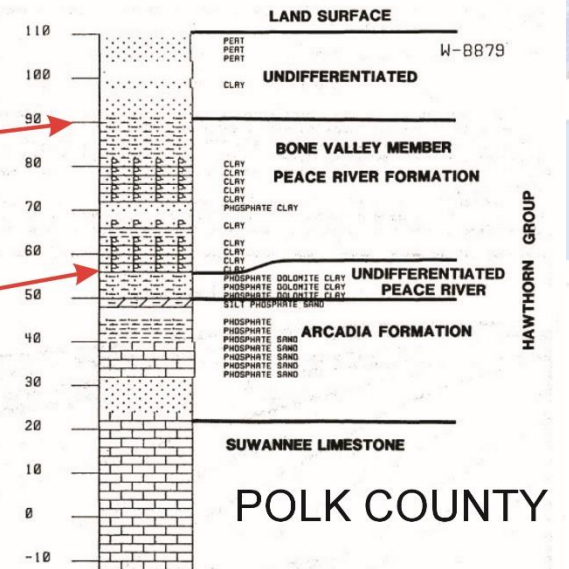

Figure 54. Reference core for the Bone Valley Member of Peace River Formation, Griffin #2, W-8879, Polk County (Lithologic legend Appendix A).

POLK COUNTY

(SCOTT, 1988)

Karst

- Mine site is located at the upper (inner) margin of the Cody Scarp

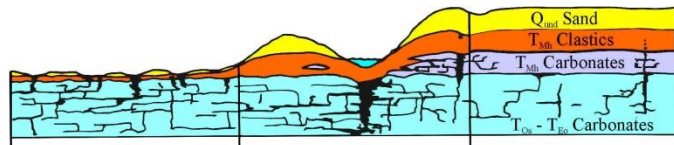

GROUND-WATER DOMAINS	LOWLAND DOMAIN	SCARP DOMAIN	UPLAND DOMAIN
SATURATION STATES		Zone of Colloidal Transport	
Calcite	undersaturated	OVER SATURATED	saturated to sl. undersat.
Dolomite	undersaturated	undersaturated	undersat. to saturated
Quartz	undersaturated to saturated	OVER SATURATED	SUPERSATURATED
Hydroxylapatite	undersaturated	SUPERSATURATED	undersaturated
KARST DEVELOPMENT			
Vertical Conduits			
Horizontal Conduits			
Intrastratal Karst			
Solution Doline Development			
Collapse Sinks			
Uvala/Polje Development			
Paleokarst Reactivation			
RECHARGE PATTERNS	DISPERSED RECHARGE	LOCAL, MAJOR RECH.	MINOR RECHARGE

Upchurch (2002)

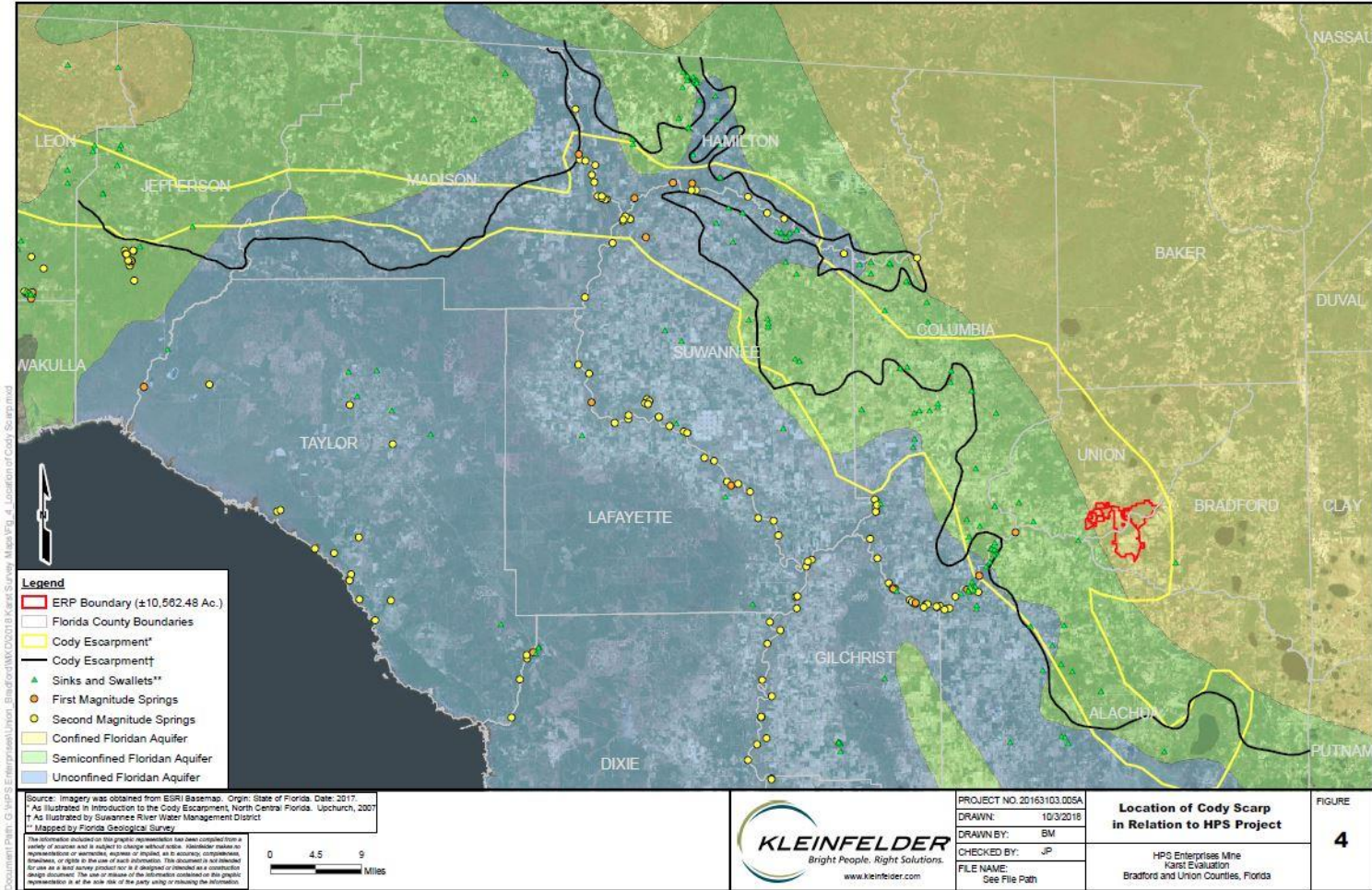

Karst

- Closed depressions are common at the upper (inner) margin of the Cody Scarp
- They have been noted on the HPSII mine site and nearby
- One monitoring well log in Karst Report (MW-18) reports “cavern” at 43 to 48 feet below land surface. Is this in the Charlton?

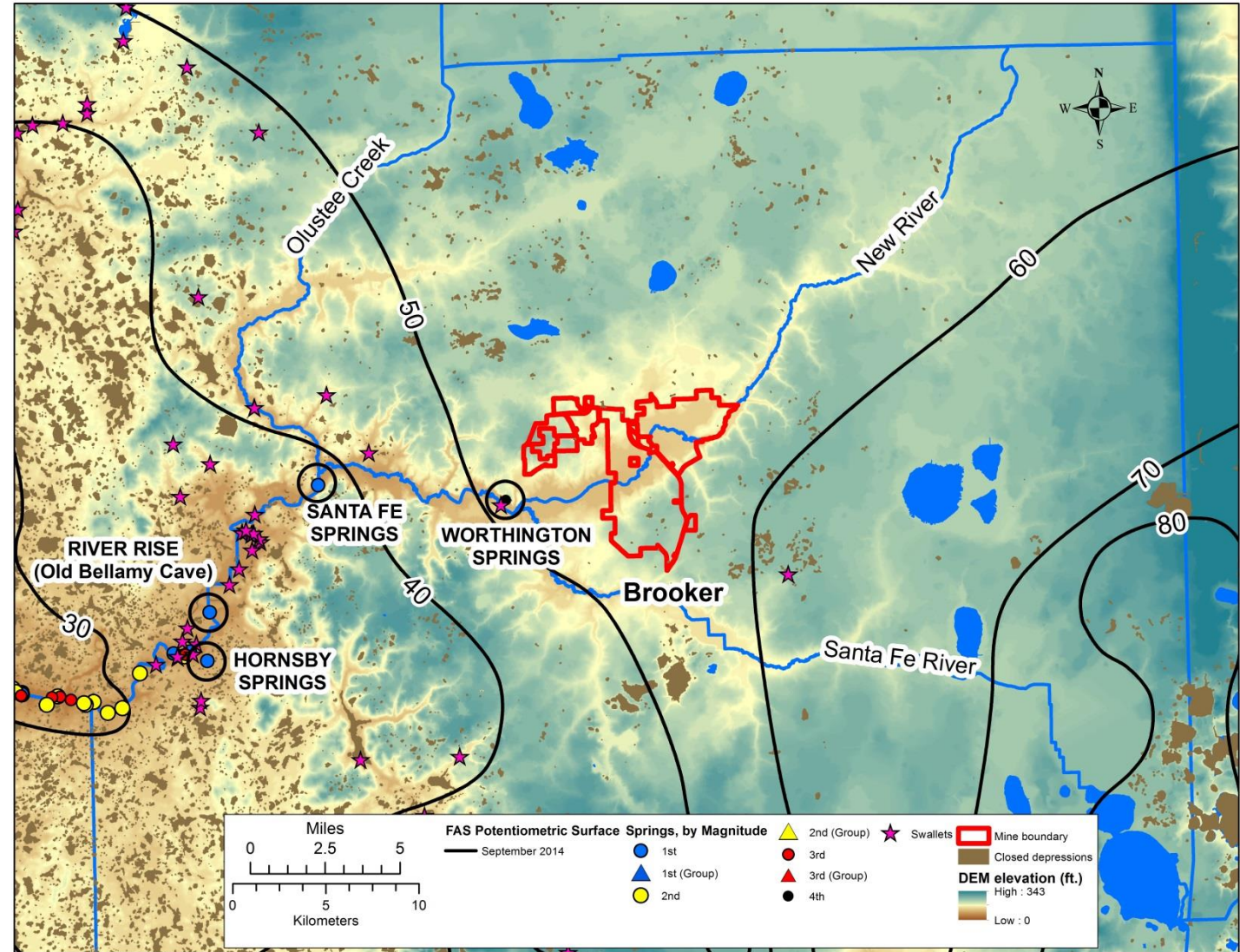

Karst

- There appear to be sinkholes on the mine property
- Known cover-collapse sinkholes exist several miles east of Brooker (i.e., Brooks Sink)
- Mining can cause sinkholes and alter water movement through existing sinks
- Need inventory of karst features
- Identify the impacts of mining on karst and recharge

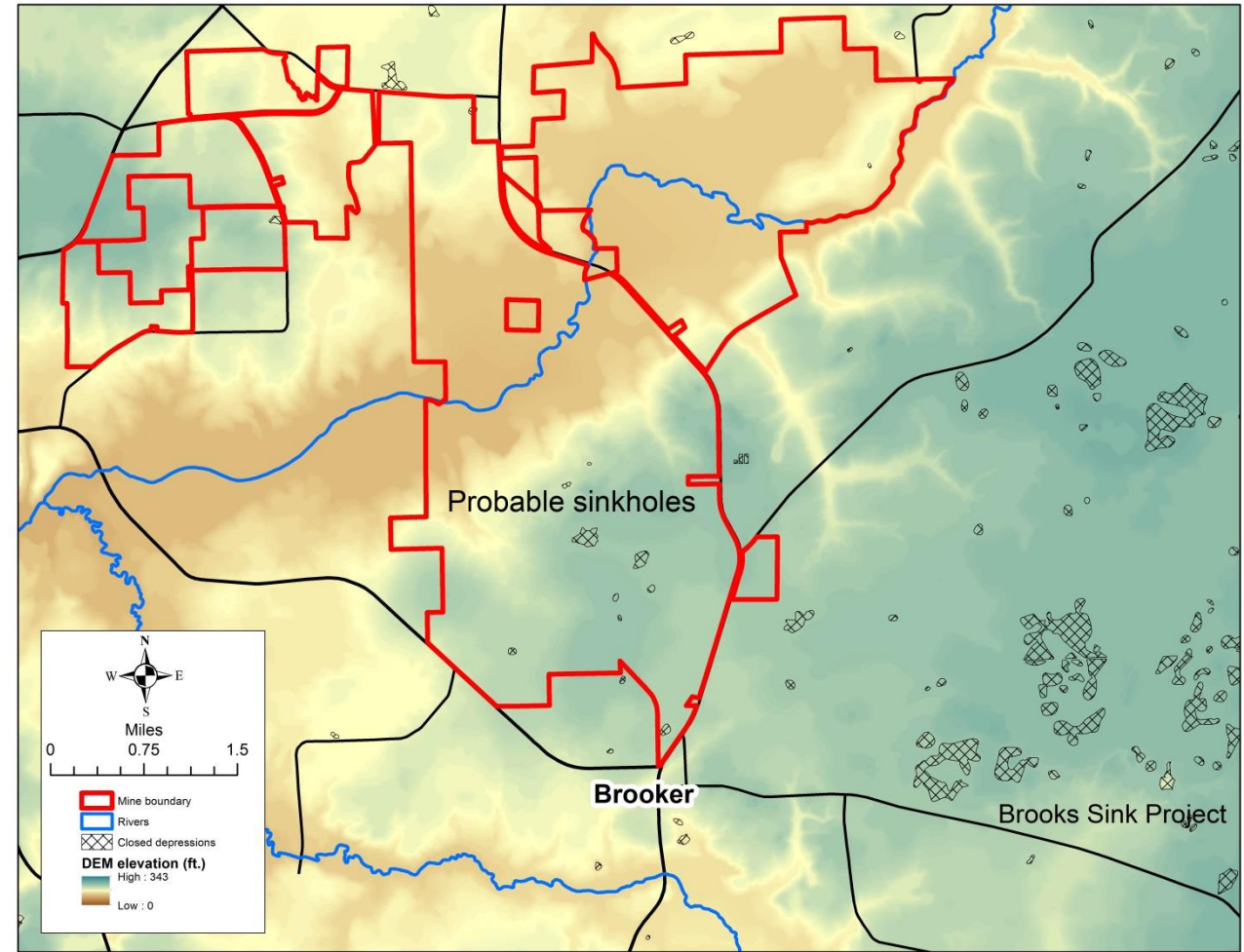

Karst

- HPSII Karst Report discusses karst and another report points out a “closed depression” in Union County.
- Closed depressions are ignored in Bradford County
- Circular wetlands and shallow closed depressions may well be relict sinkholes
- HPSII map assumes that Florida Geological Survey’s “Subsidence Incidence Database” is
 - Valid and comprehensive sinkhole database (it is not, as acknowledged by FGS)
 - Only modern “sinkholes” reported on the database are actual sinkholes

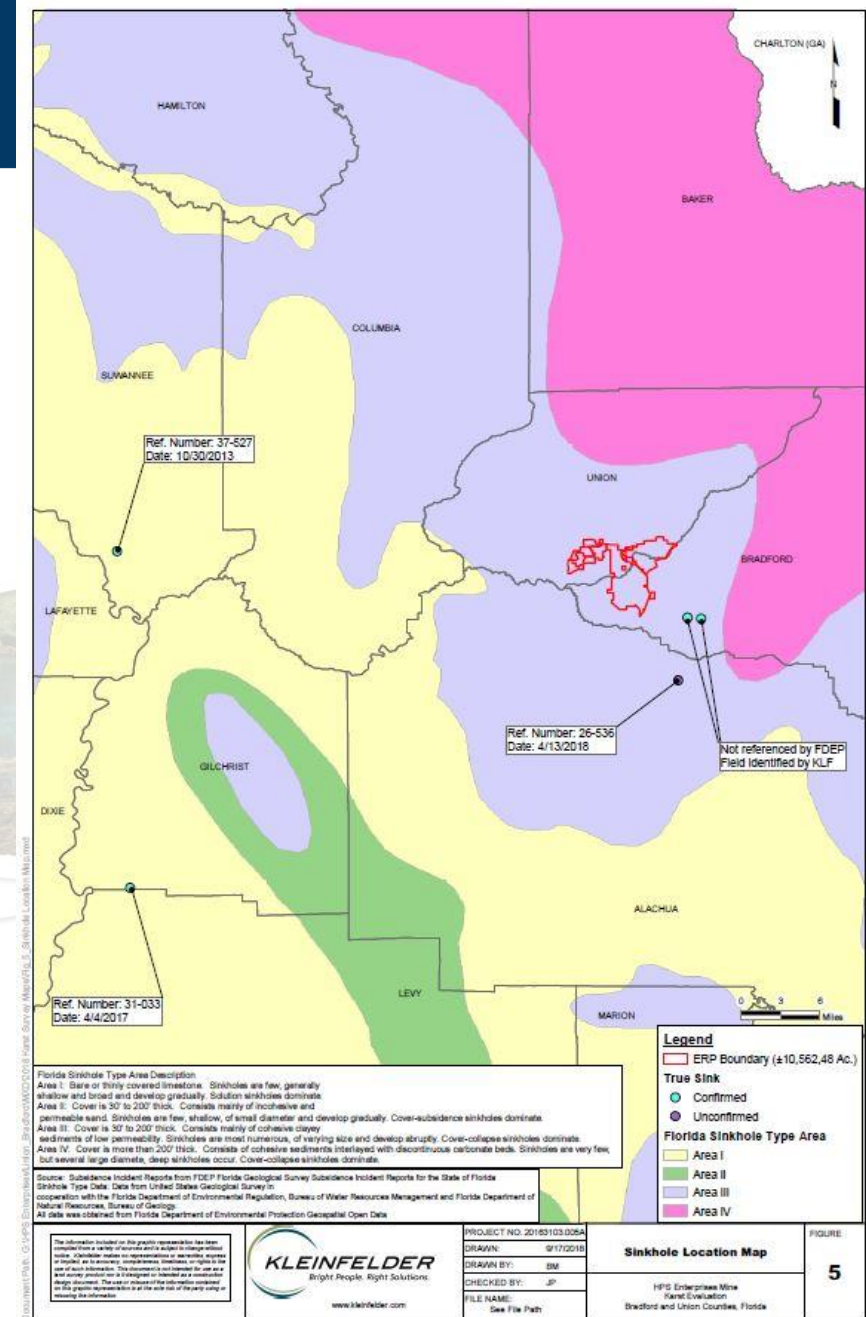

Brooks Sink Project

- Need to assess the impact of water use at the mine on the success of this project
- Brooks Sink is a cover-collapse sinkhole approximately 4 miles due east of Brooker
- The SRWMD and Rayonier Operating Company, LLC are improving recharge to the Floridan aquifer through the sink

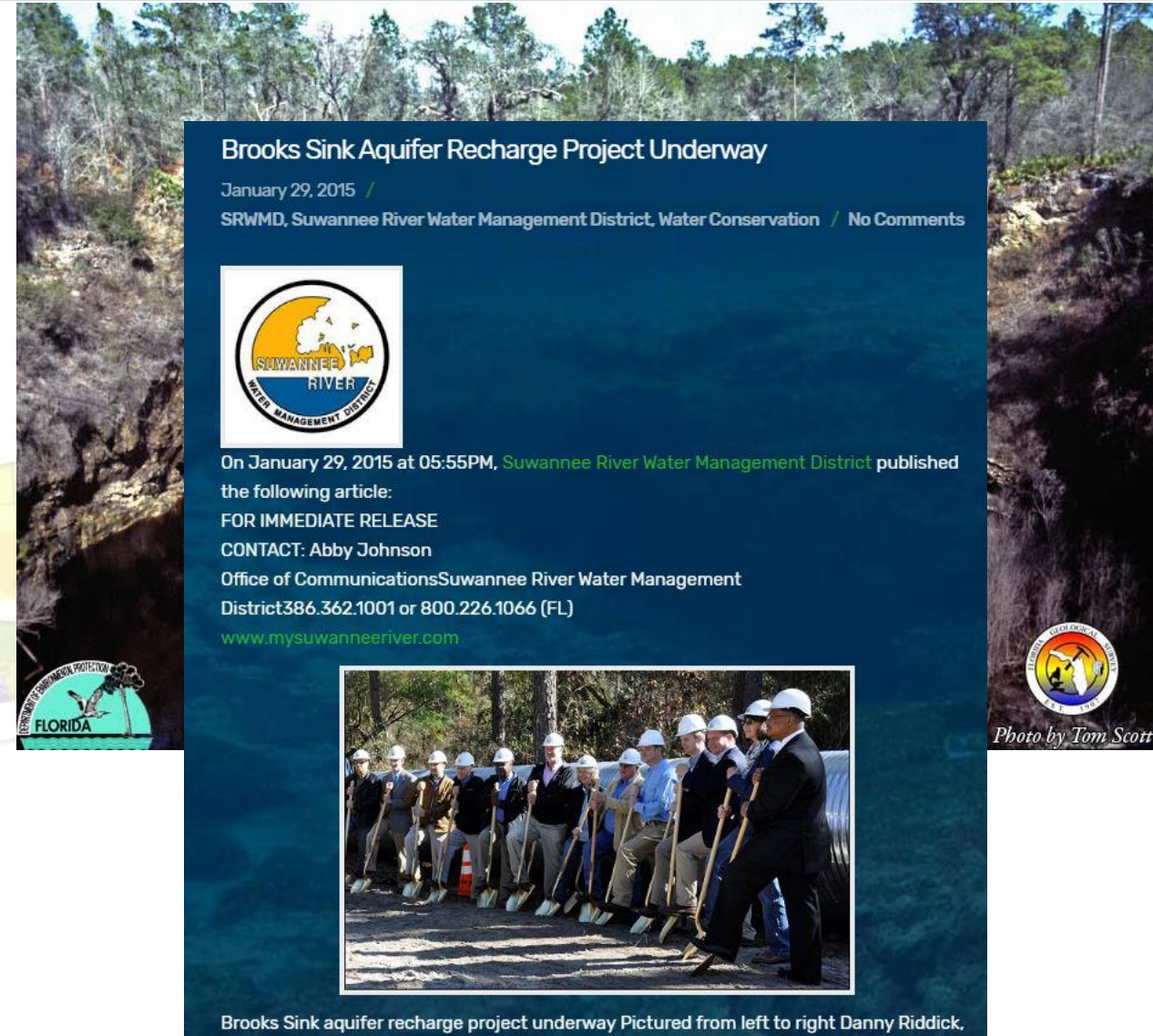

Brooks Sink Aquifer Recharge Project Underway
January 29, 2015 /
SRWMD, Suwannee River Water Management District, Water Conservation / No Comments



On January 29, 2015 at 05:55PM, [Suwannee River Water Management District](#) published the following article:
FOR IMMEDIATE RELEASE
CONTACT: Abby Johnson
Office of Communications
Suwannee River Water Management District
386.362.1001 or 800.226.1066 (FL)
www.mysuwanneeriver.com



Brooks Sink aquifer recharge project underway Pictured from left to right Danny Riddick.



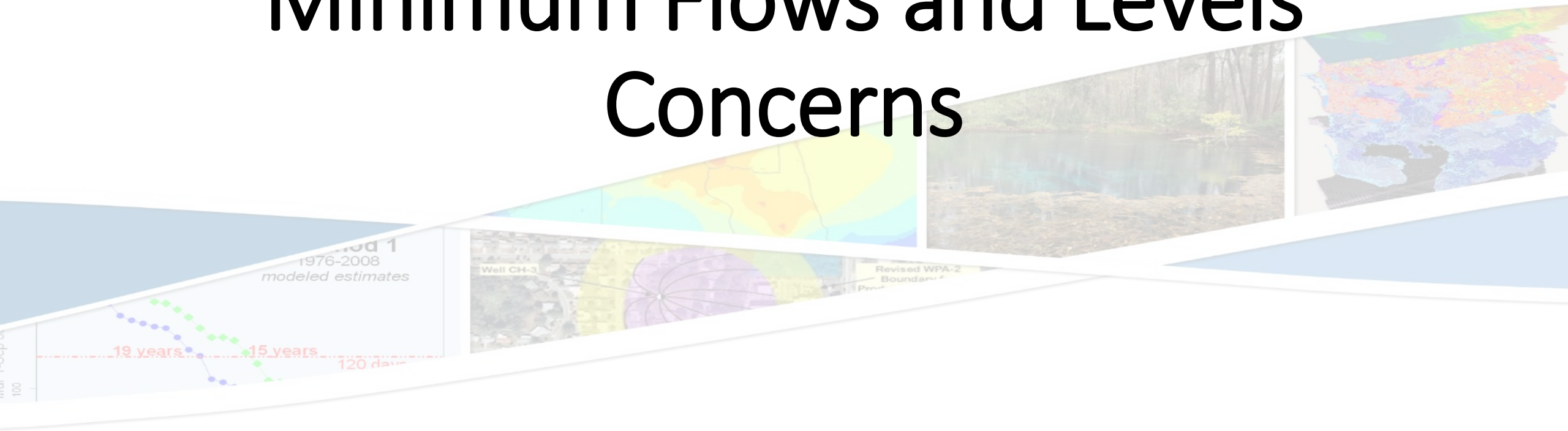
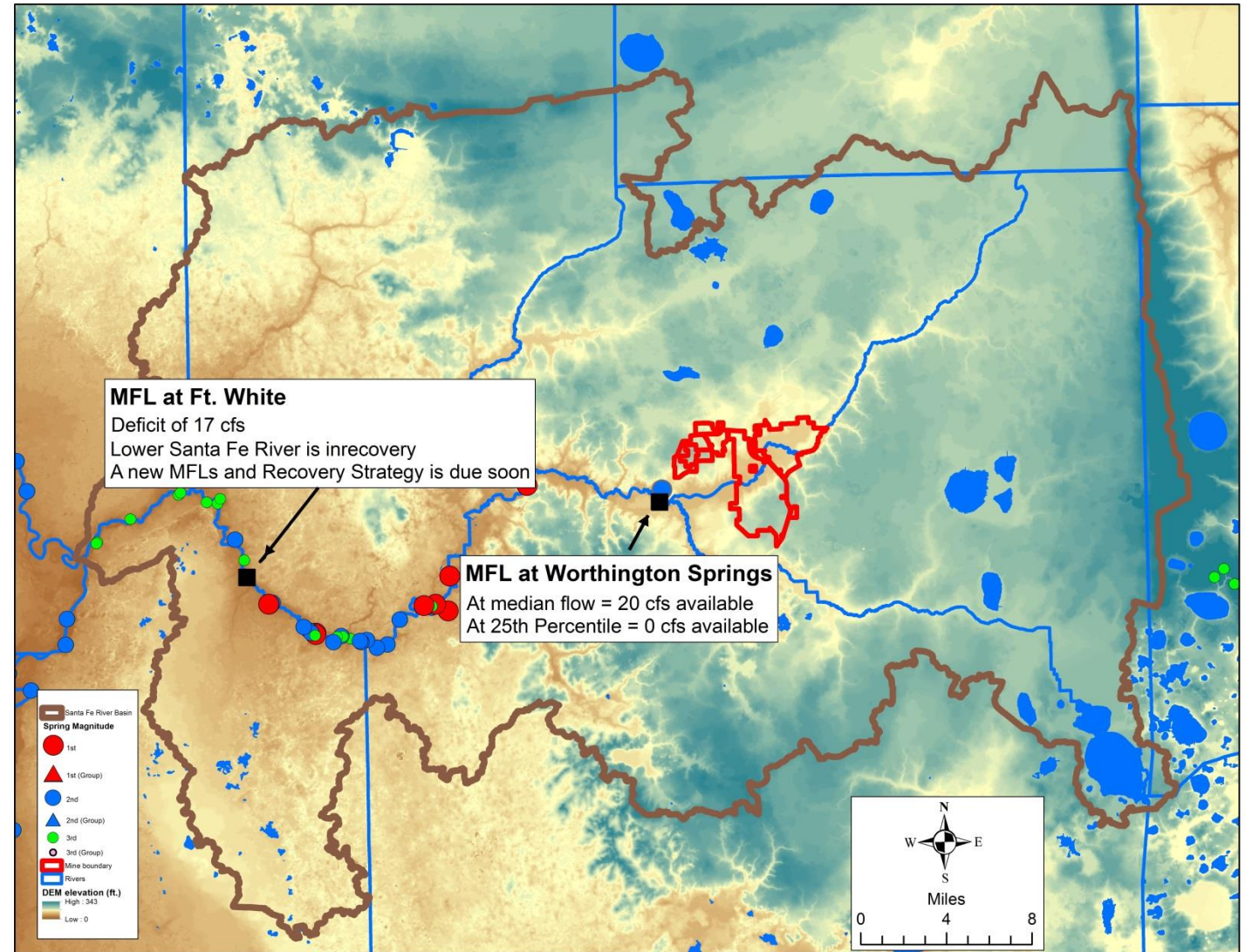
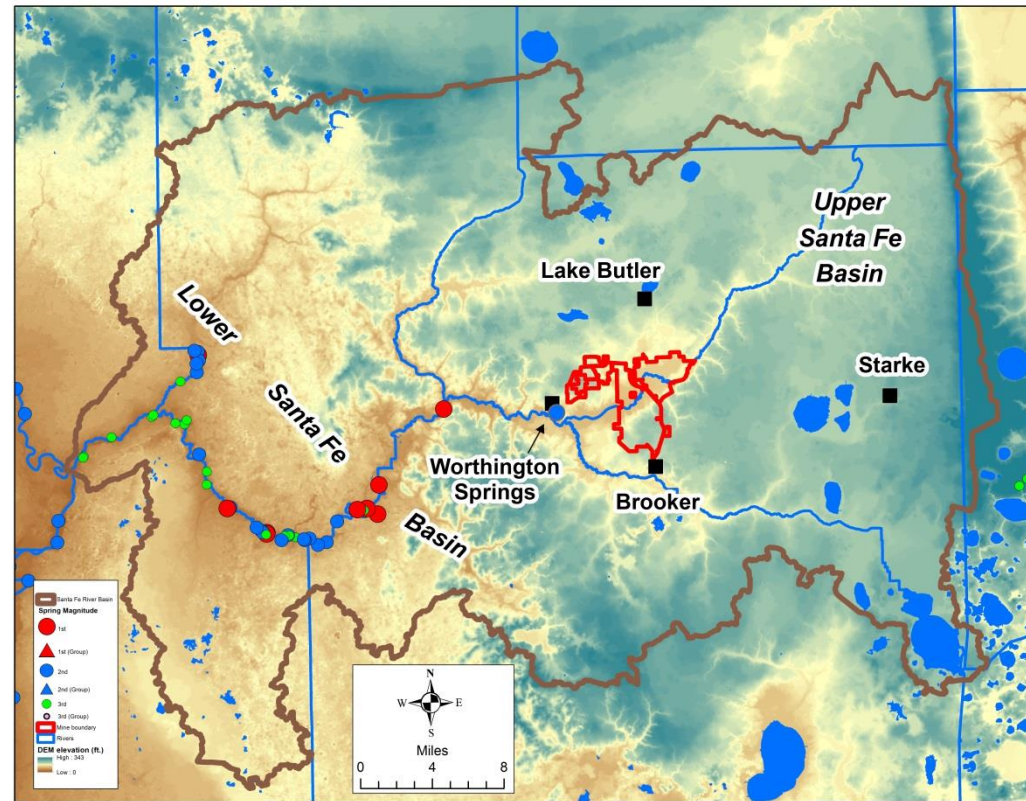

Photo by Tom Scott

Minimum Flows and Levels Concerns



Existing MFLs



Minimum Flows and Levels exist for the entire Santa Fe Basin

Minimum Flows and Levels

- The New River is part of the Upper and Lower Santa Fe River systems, both of which have existing MFLs
 - Lower Santa Fe River MFL is temporary waiting on development of the North Florida – Southeast Georgia groundwater flow model
 - The model is a joint effort of the SRWMD and SJRWMD
 - Almost certainly, water in the Lower Santa Fe will remain over committed and IN RECOVERY
- The Lower Santa Fe River is in recovery and the Upper Santa Fe has no available water during low flows
- LSFR MFL Recovery Plan goals:
 - Achieve the restoration of the Lower Santa Fe and Ichetucknee Rivers and their priority springs to their proposed minimum flows.
 - Develop measures to provide sufficient water supplies for existing and projected reasonable-beneficial uses as practical.

Minimum Flows and Levels

- LSRF MFL Recovery Plan Phase 1 DEP actions include:
 - Implement supplemental review criteria for individual water use permit applicants: offset of new impacts to recovering MFL water bodies and limited duration permits for existing impacts
 - Implement special condition to ensure uses comply with future recovery measures.
- LSRF MFL Recovery Plan Phase 2 DEP actions include:
 - Based on results of regional model analysis, assessment for major users/groups, and magnitude of prevention/recovery needed, identify water supply measures needed to achieve MFLs.
 - Use regional model analysis, MFLs constraints, project concepts, and related information to determine regional water availability for existing and new sources. Implement long-term regulatory measures as required to achieve MFLs.

Minimum Flows and Levels

- SRWMD and SJRWMD have been a regional groundwater model called the North Florida Southeast Georgia (NFSEG) whose purpose included the evaluation of the Lower Santa Fe River MFL
- SRWMD and DEP are on schedule to initiate rulemaking to the revised Lower Santa Fe River MFL and Recovery Strategy by December 31, 2019
- No mention of the need for compliance with the existing MFLs and associated recovery plans nor the North Florida Regional Water Supply Plan.
- Need to analyze the effects of mining and reclamation on the MFLs and flow regimes in the Upper and Lower Santa Fe River drainage systems
- The proposed mine must take into account the revised MFL and Recovery Strategy and should employ the NFSEG model

Nutrient Concerns

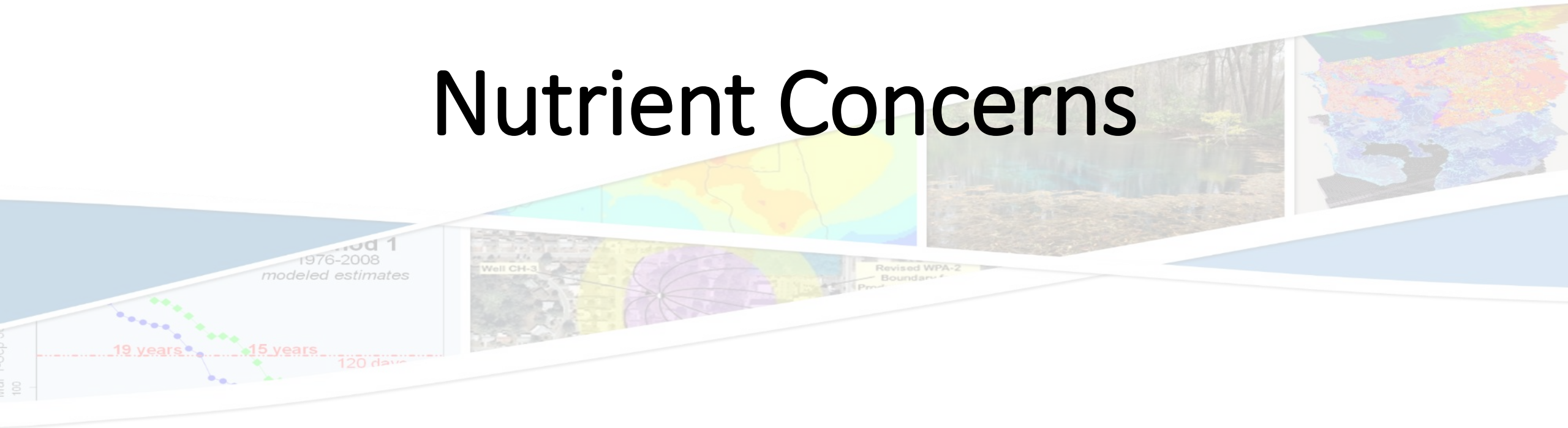

TMDLs and BMAPs

- FDEP adopted the TMDLs for 2 WBIDs within the Santa Fe River Basin in September 2008.
- Both WBIDs are impaired due to noncompliance with dissolved oxygen standards
- New River is also impaired for TN and TP exceedances

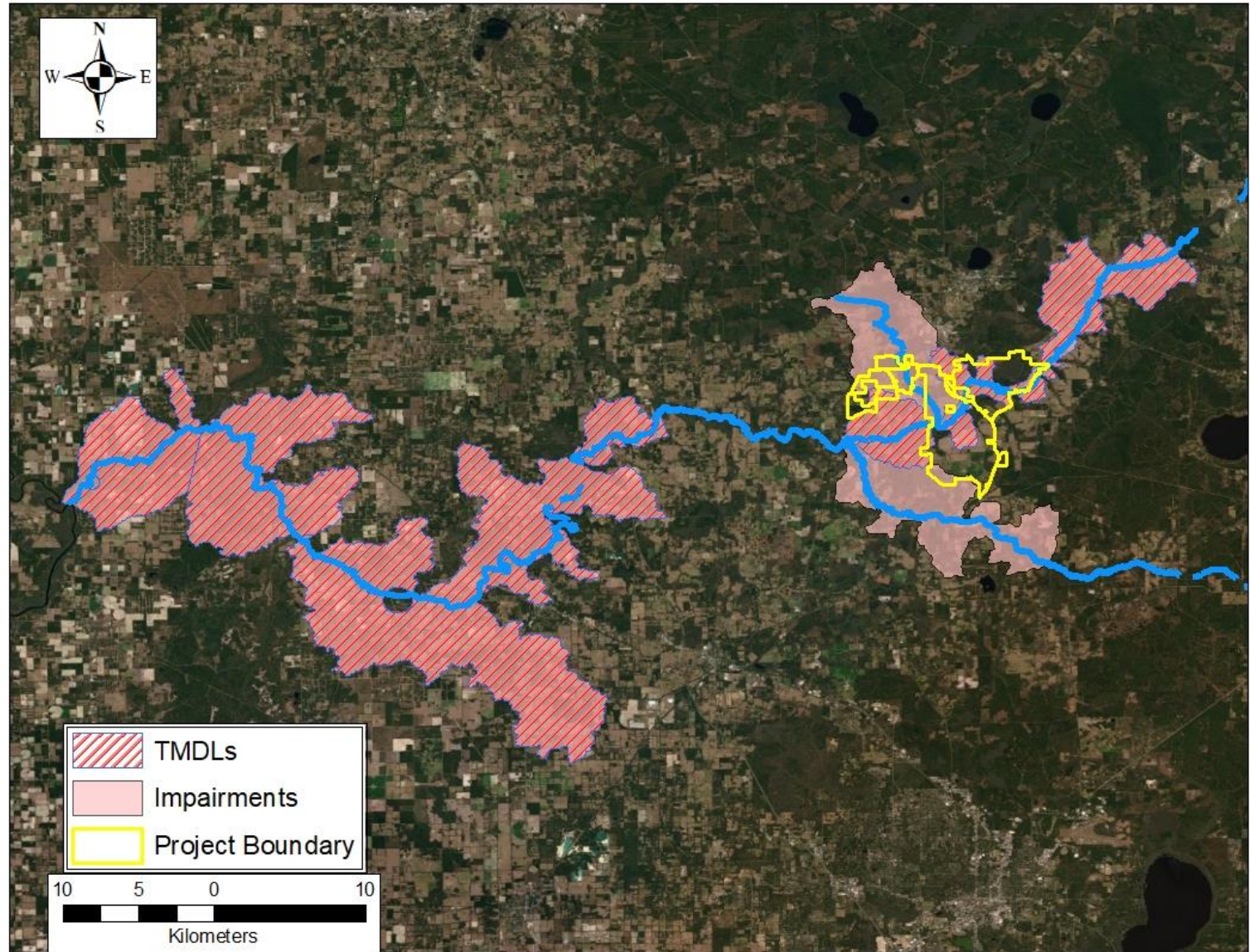

TMDLs and BMAPs

- The Total Maximum Daily Load (TMDL) target developed for the Lower Santa Fe River is a monthly average of 0.35 milligrams per liter [mg/L] of nitrate [NO_3] and was determined to be sufficiently protective of the aquatic flora or fauna in the Lower Santa Fe River
- The TMDL targets in the New River are $\text{TN}=1.5$ mg/L and $\text{TP}=0.013$ mg/L
- Need to analyze the effects of mining and reclamation on the nutrient concentrations to document compliance with the TMDL as well as future compliance with other numeric nutrient criteria and DO standards

Wetland Concerns

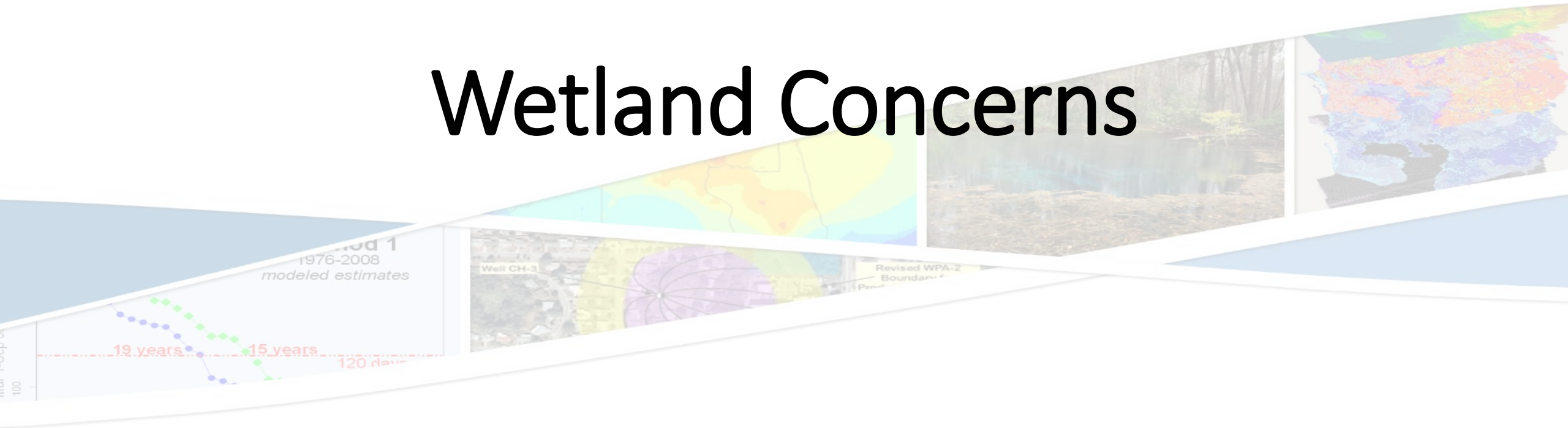

Upper Floodplain Connection

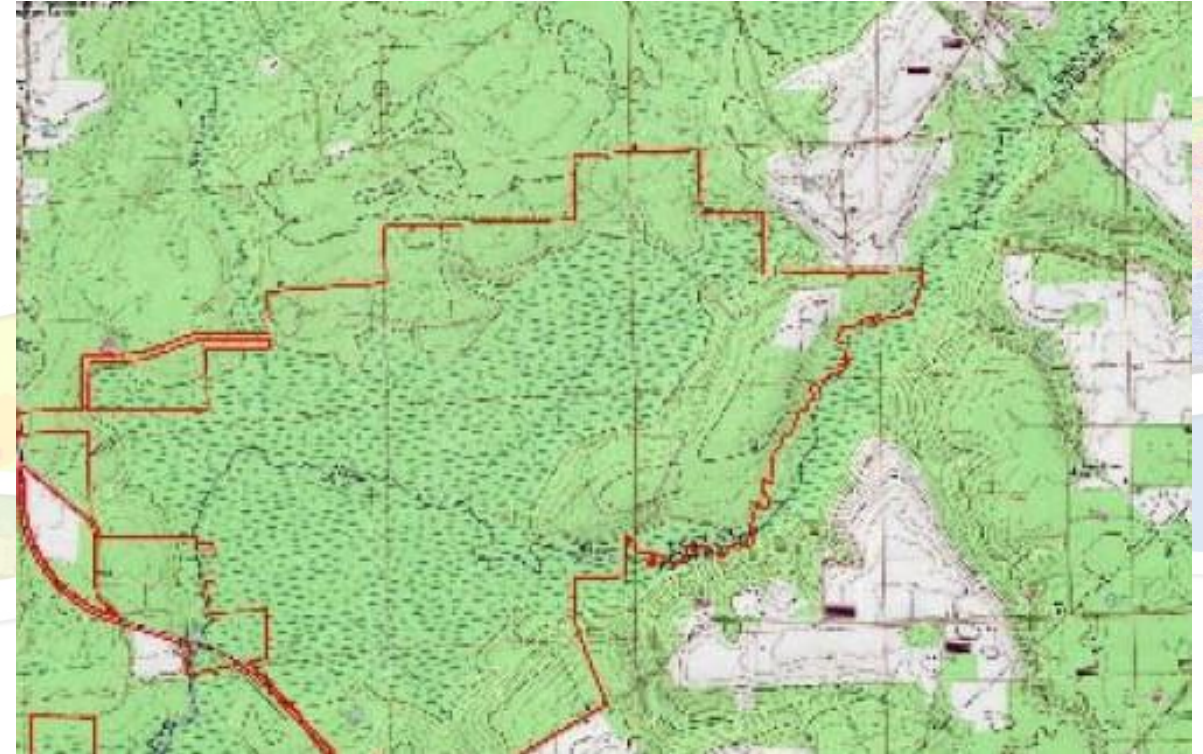
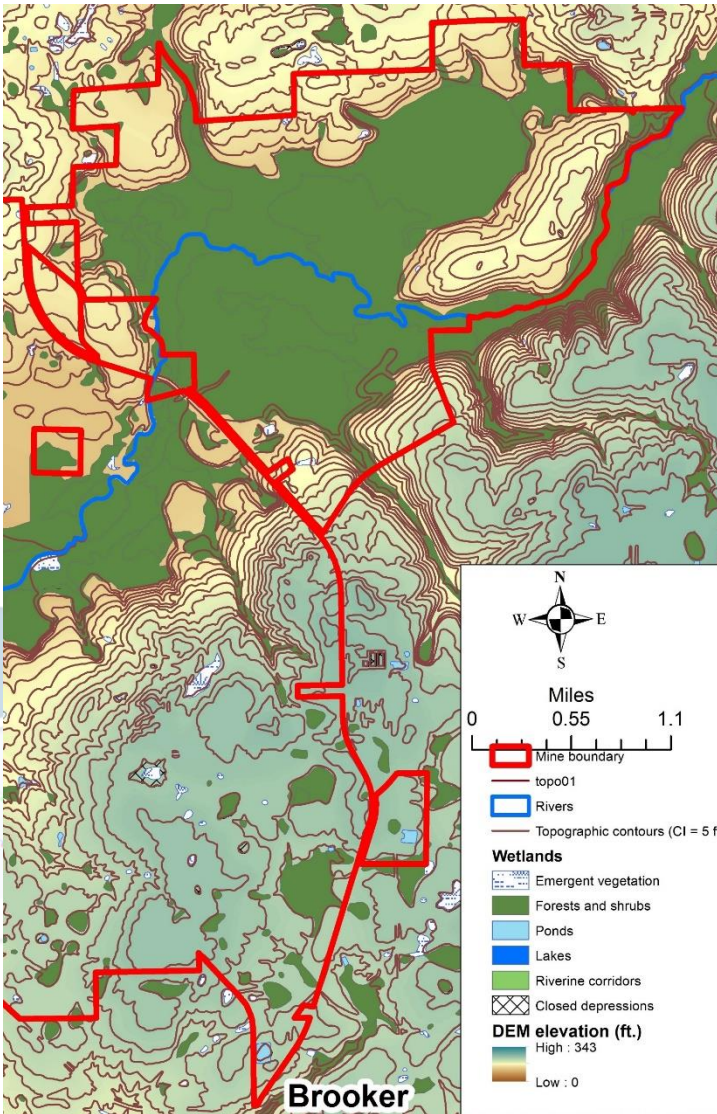

Jurisdictional Wetlands ERP 3/19

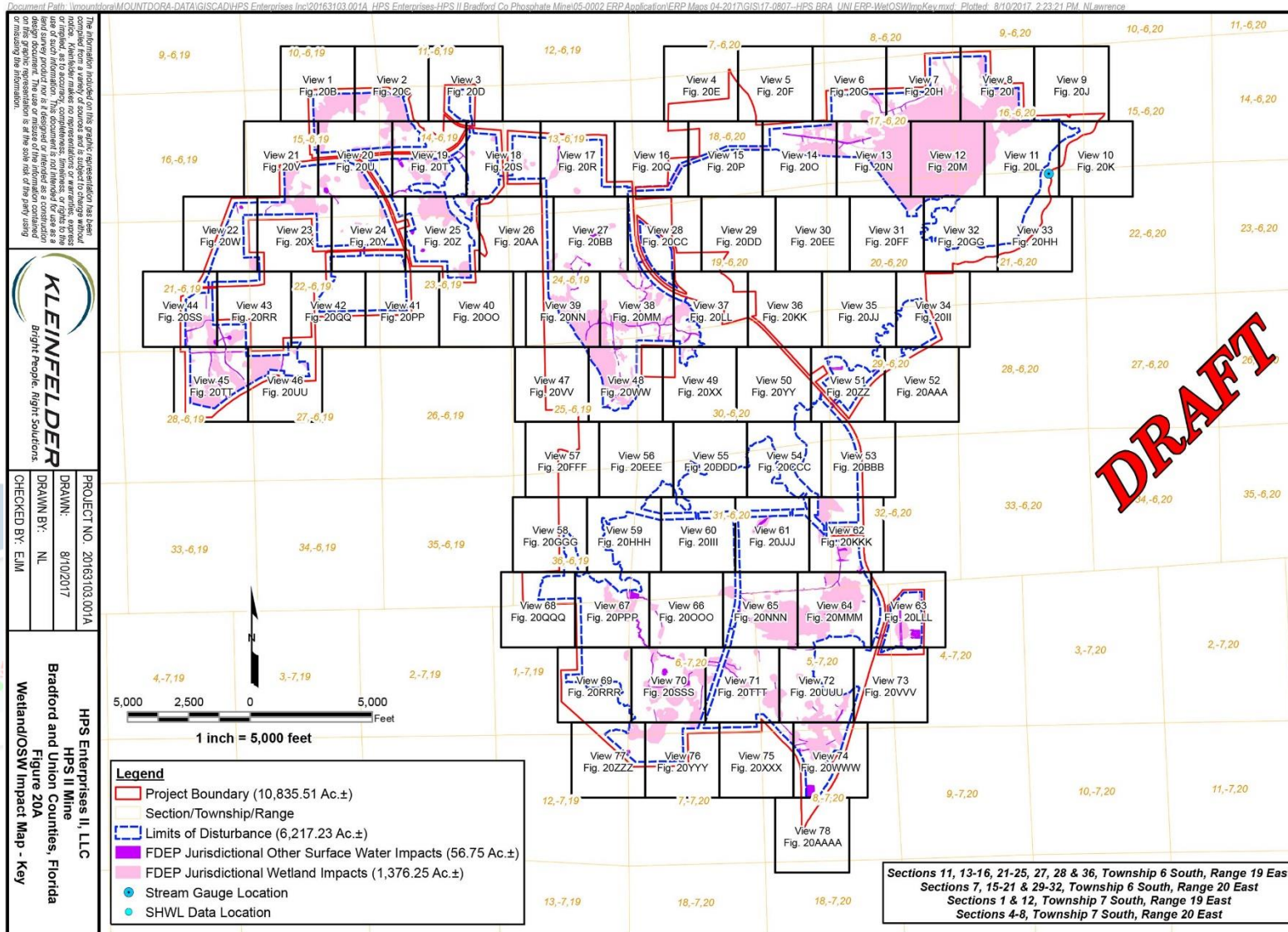

Sam Upchurch

Thomas Crisman

Mining Plan Floodplain Connection ERP 2/19

Note the diked channel to ensure stream connection

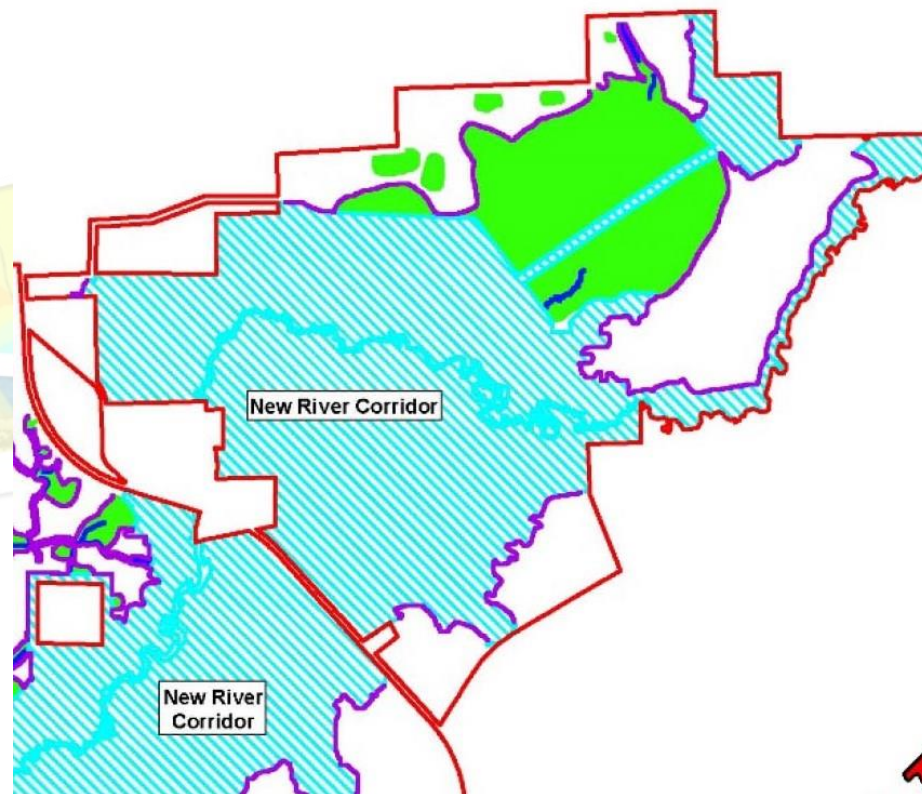
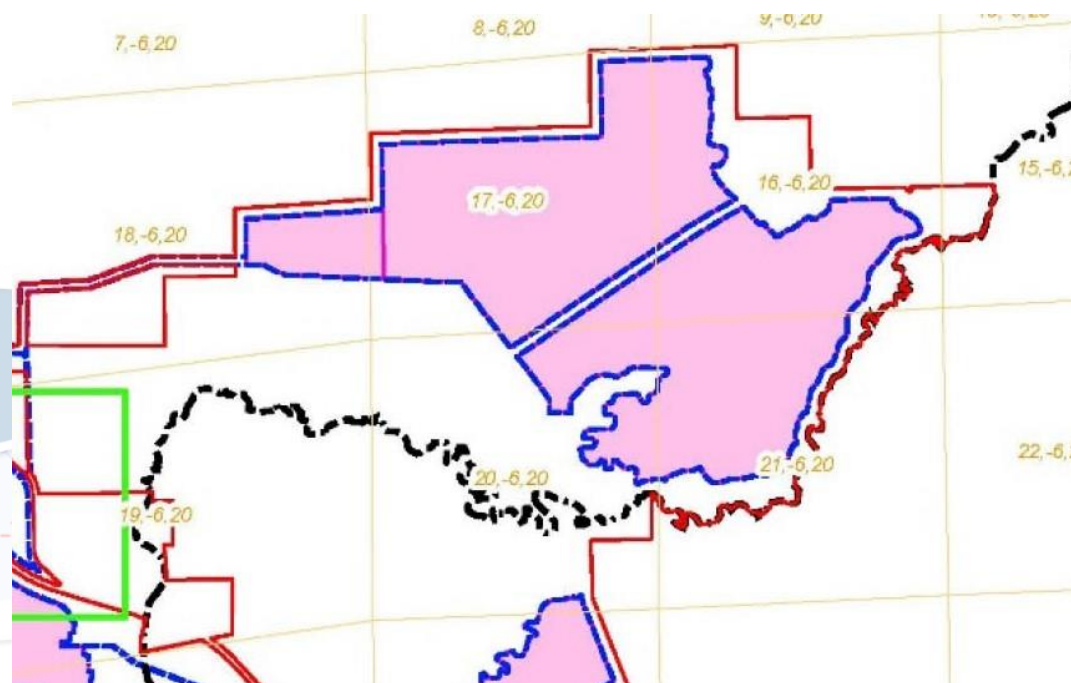

Upper Floodplain Connection ERP 3/19

Note blockage of river entry and lack of connection to lower floodplain

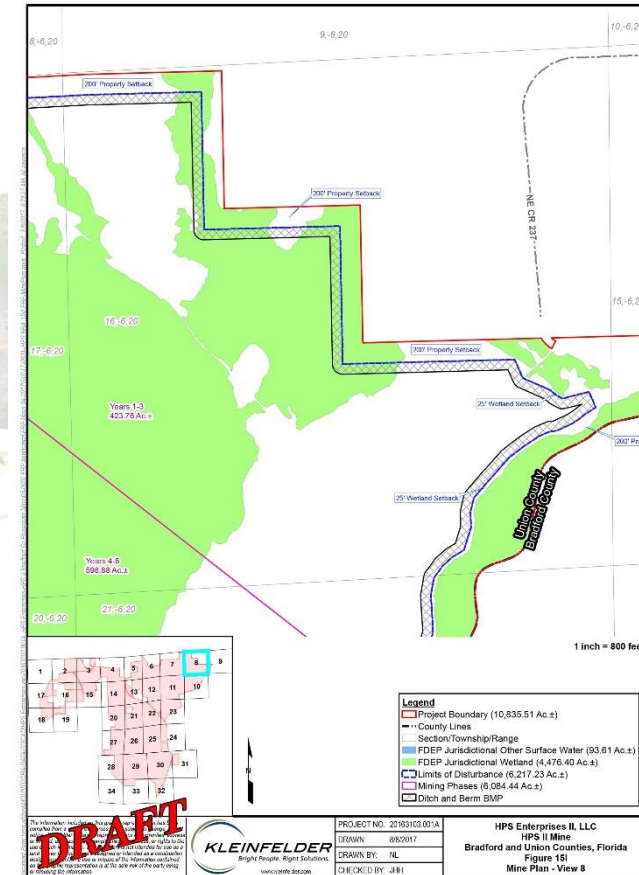
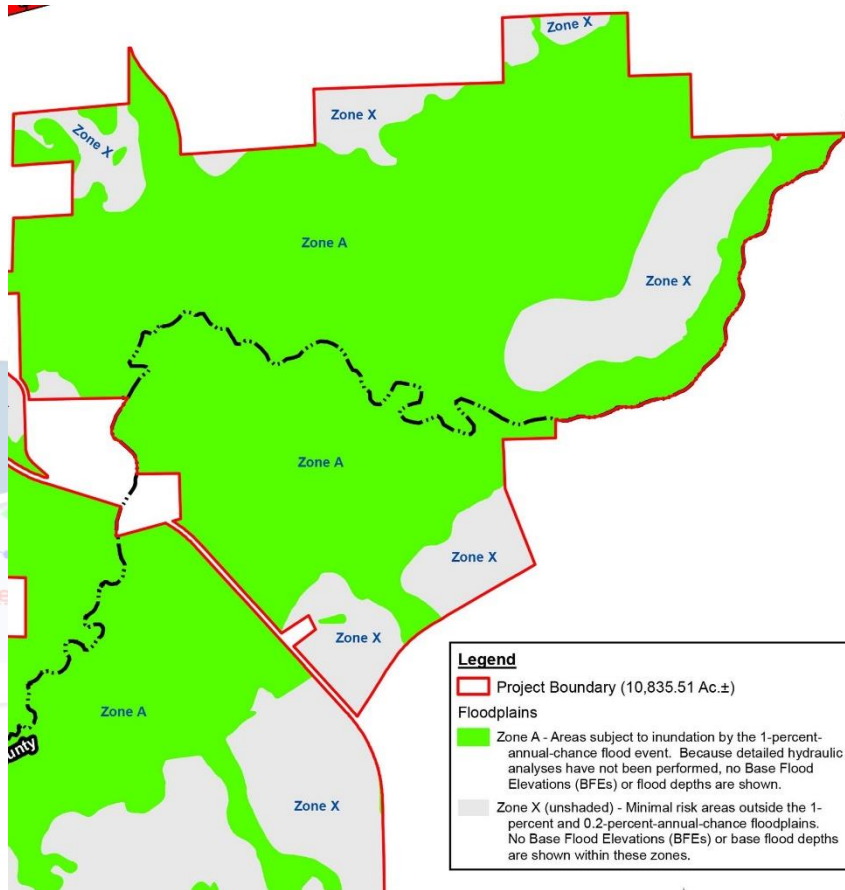

Mined Area ERP 3/25

- Disconnect of river from floodplain
- No hydrologic connection through mined area

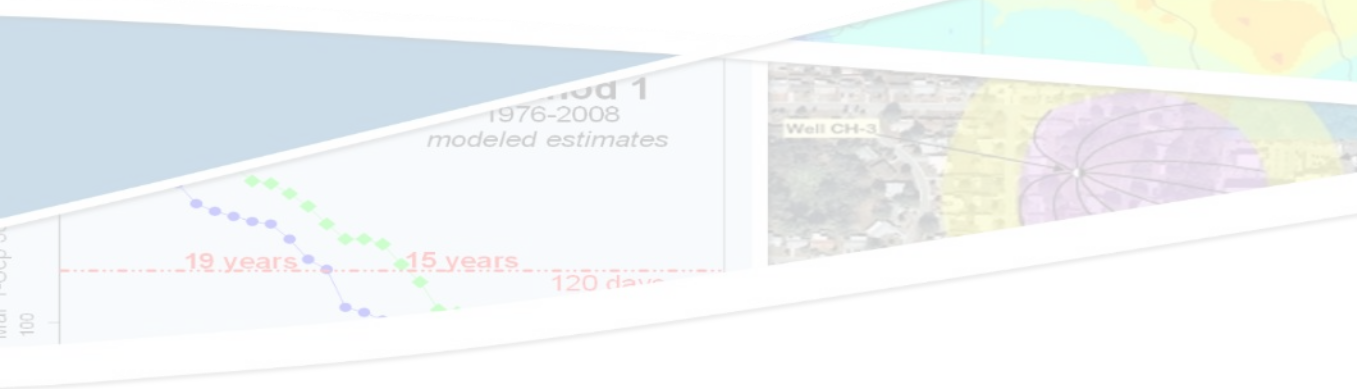
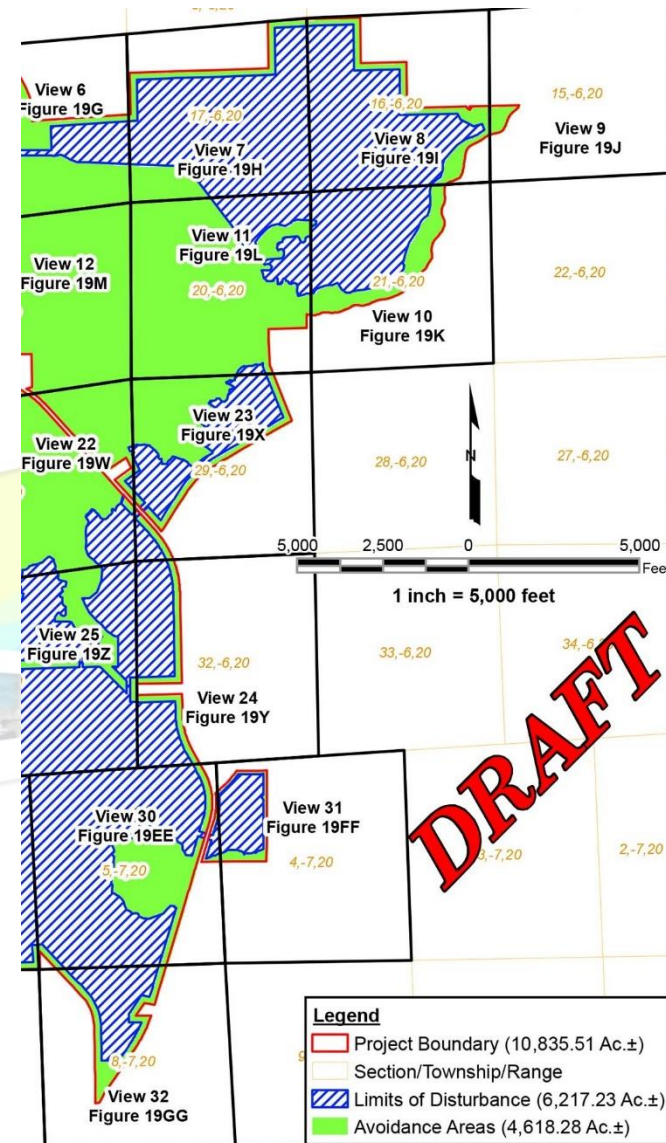

Pre- and Post- Mining Land Use ERP 2/19

Pre-Mining Land Use

Post-Mining Land Use

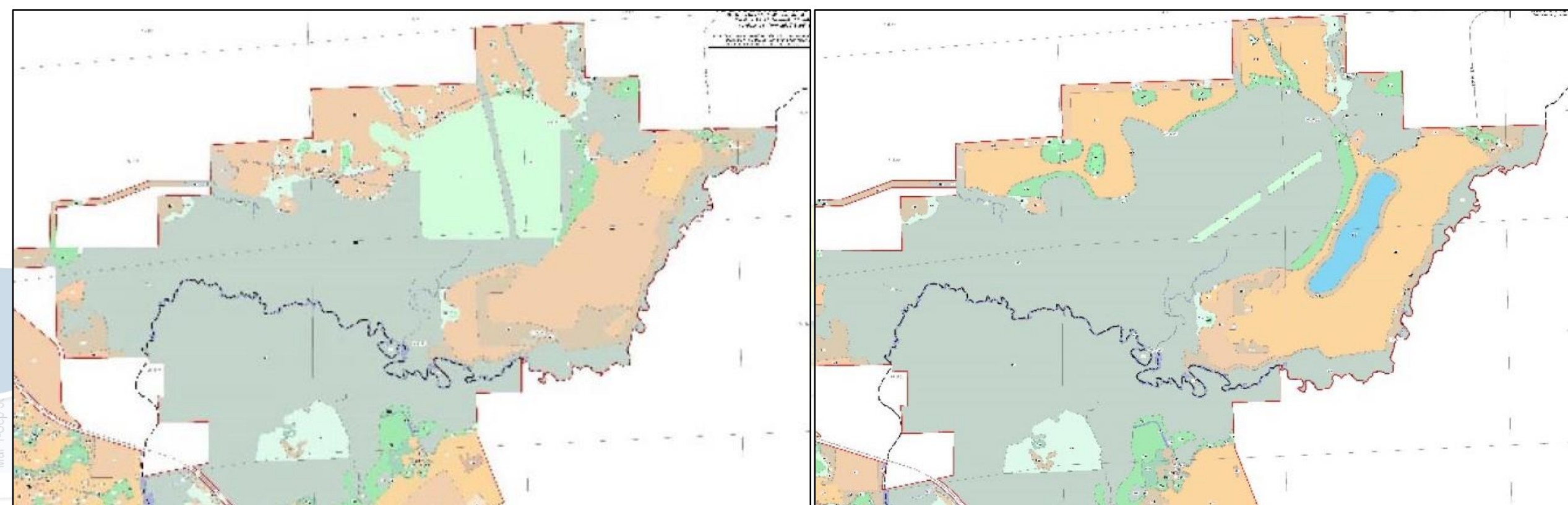

Wetland Reclamation & Enhancement ERP 2/19

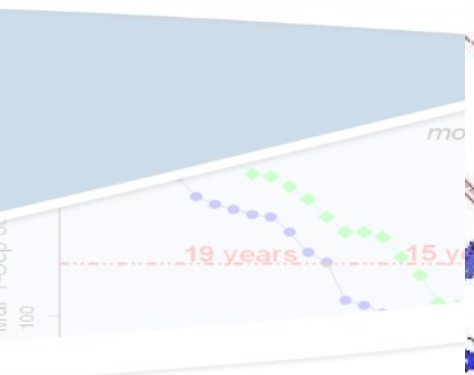
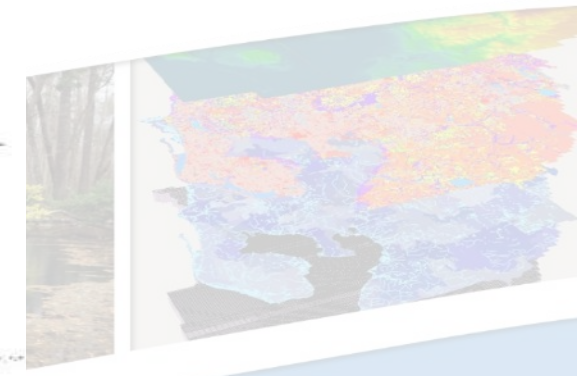
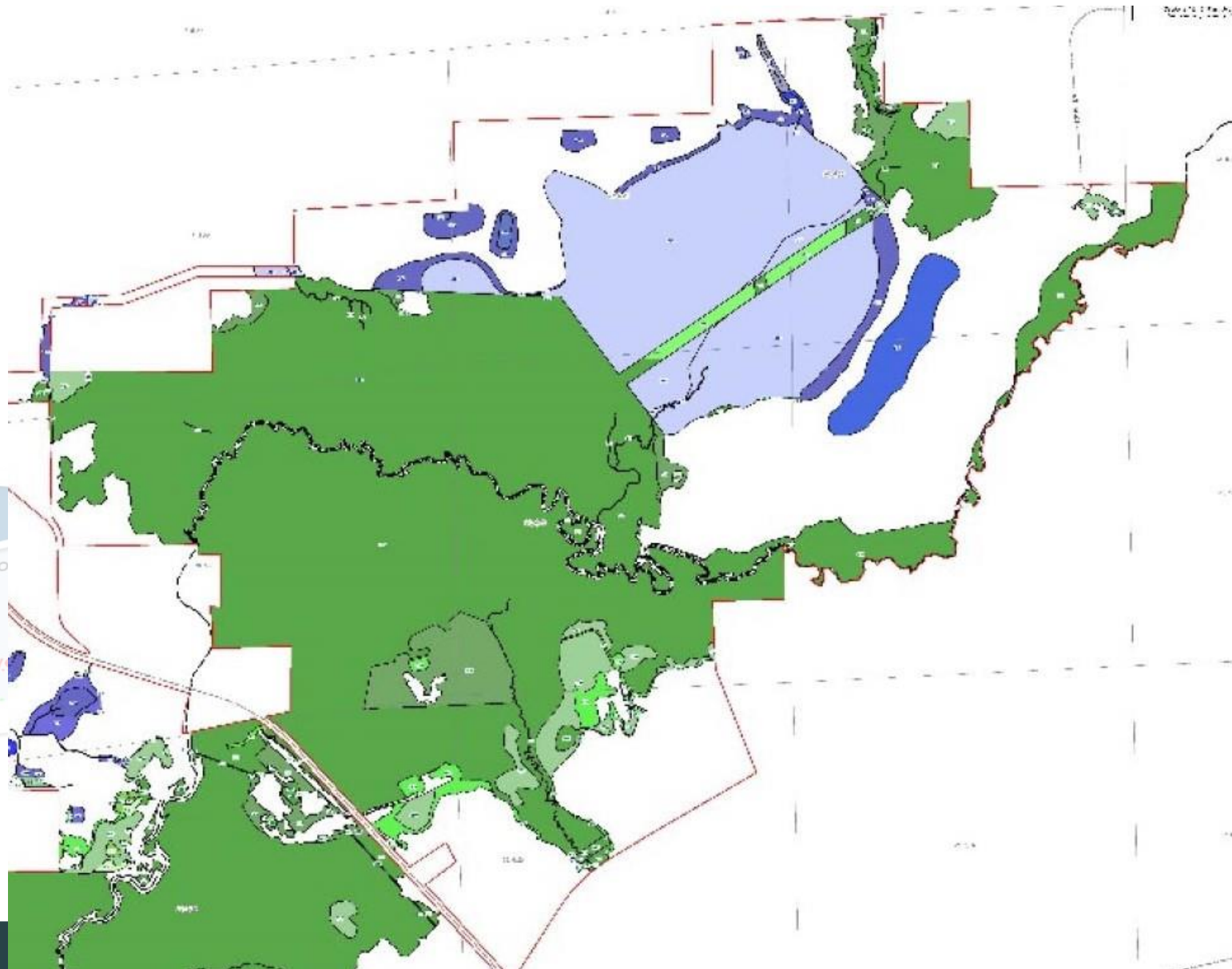

Mitigation ERP 2/19

ERP Mitigation

- Conservation easements to be provided over avoided areas (1,722.05 acres) as mitigation
- Acre for acre type for type reclamation of wetlands and floodplains; foot-for-foot restoration for streams
- ERP & CRP must be in place prior to any land disturbance on site
- # FS 373.414 (6) (6). May be appropriate only if they maintain or improve water quality & function of biological functions prior to commencement of mining

Reclamation & UMAM ERP 2/19

Pre-Post Reclamation Wetlands and Streams:

Wetland/OSW Type	Pre-mining (Acres, linear feet)	Post-Mining (Acres, Linear Ft.)
Herbaceous Wetlands	390.73	398.82
Forested Wetlands	3,940.55	3961.32
Streams (511, 512)	142,761.84 linear ft.	145,181.89 linear ft.

UMAM Summary:

Impact or Mitigation Type	Impacts - Functional Loss (Units)	Mitigation - Functional Gain (Units)
Forested Wetlands	773.46	989.94
Herbaceous Wetlands	137.34	126.34
Other surface waters	*18.00	4.29 ac.
Total	928.8	1,120.57

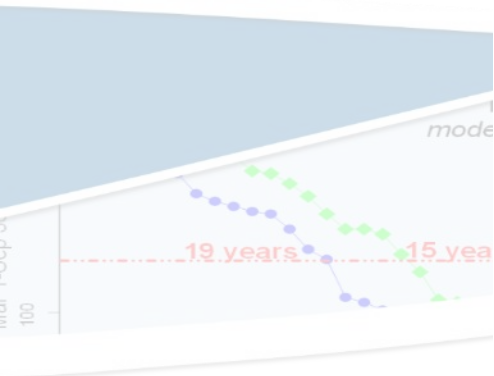
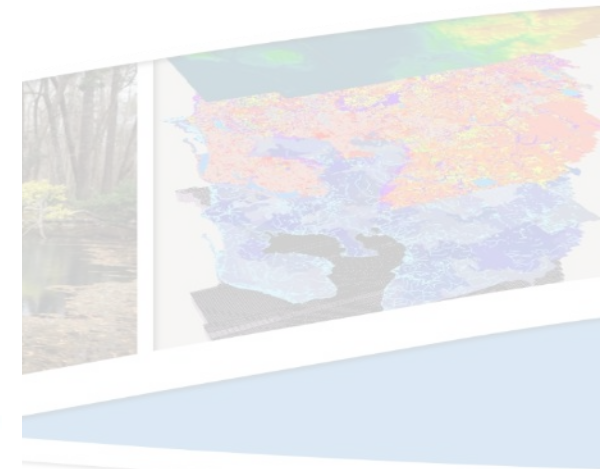

Bear Habitat ERP 3/19

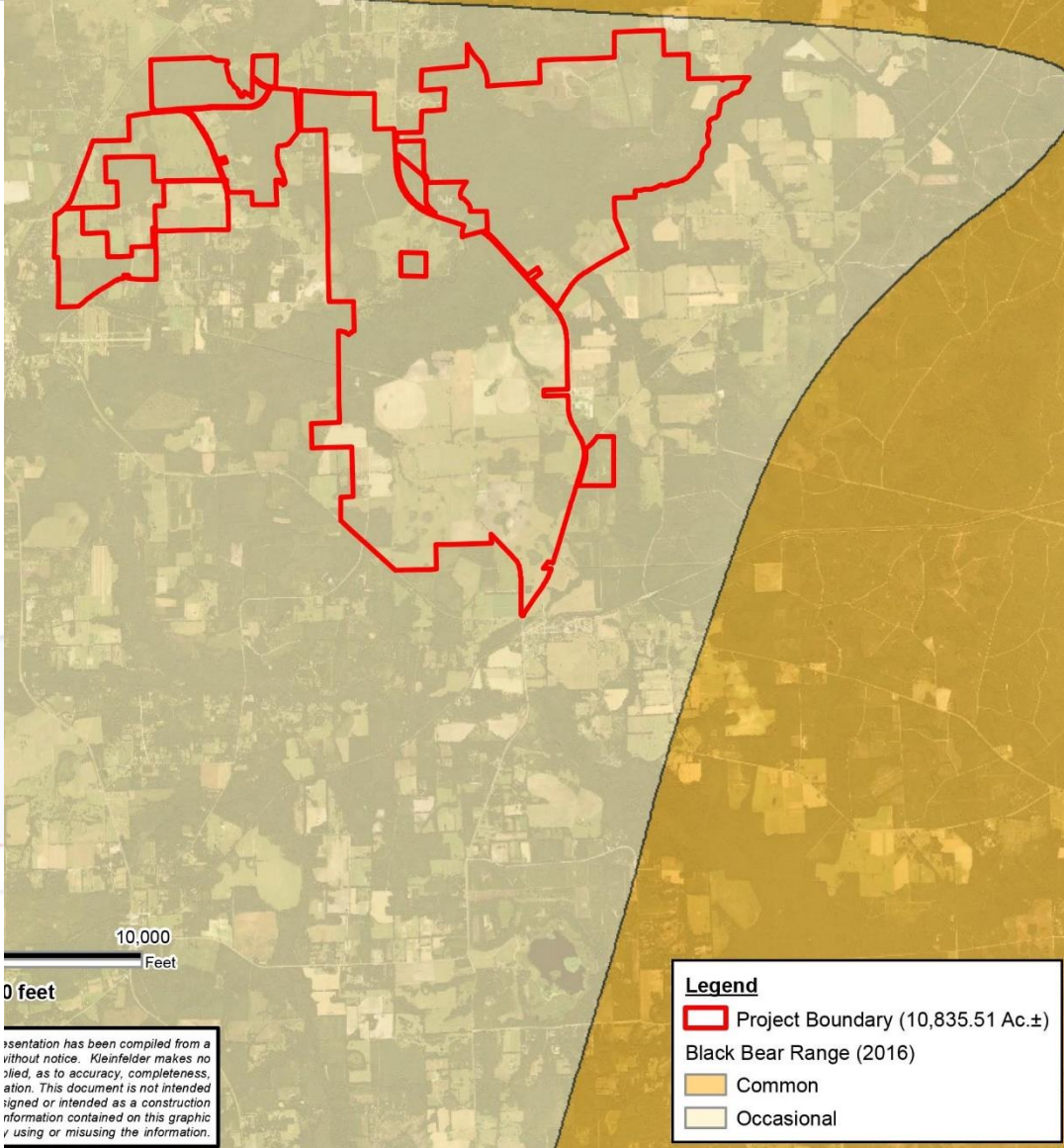
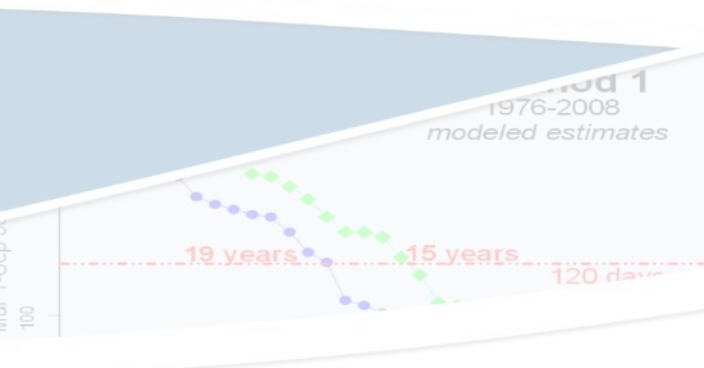

resentation has been compiled from a without notice. Kleinfelder makes no lied, as to accuracy, completeness, ation. This document is not intended signed or intended as a construction information contained on this graphic v using or misusing the information.

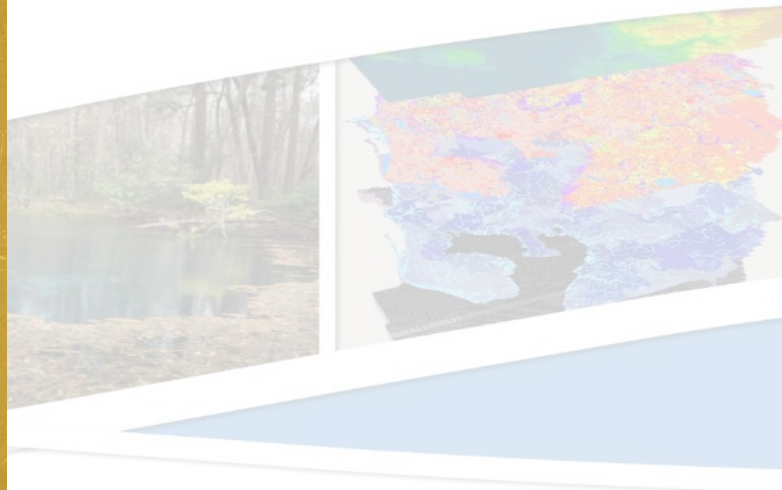

Floodplain Wetlands Currently Trap Sediment

TRANSECT 1 – FACING LEFT DOWNSTREAM BANK



TRANSECT 4 – FACING UPSTREAM



Suwannee Moccasinshell (*Medionidus walkeri*)

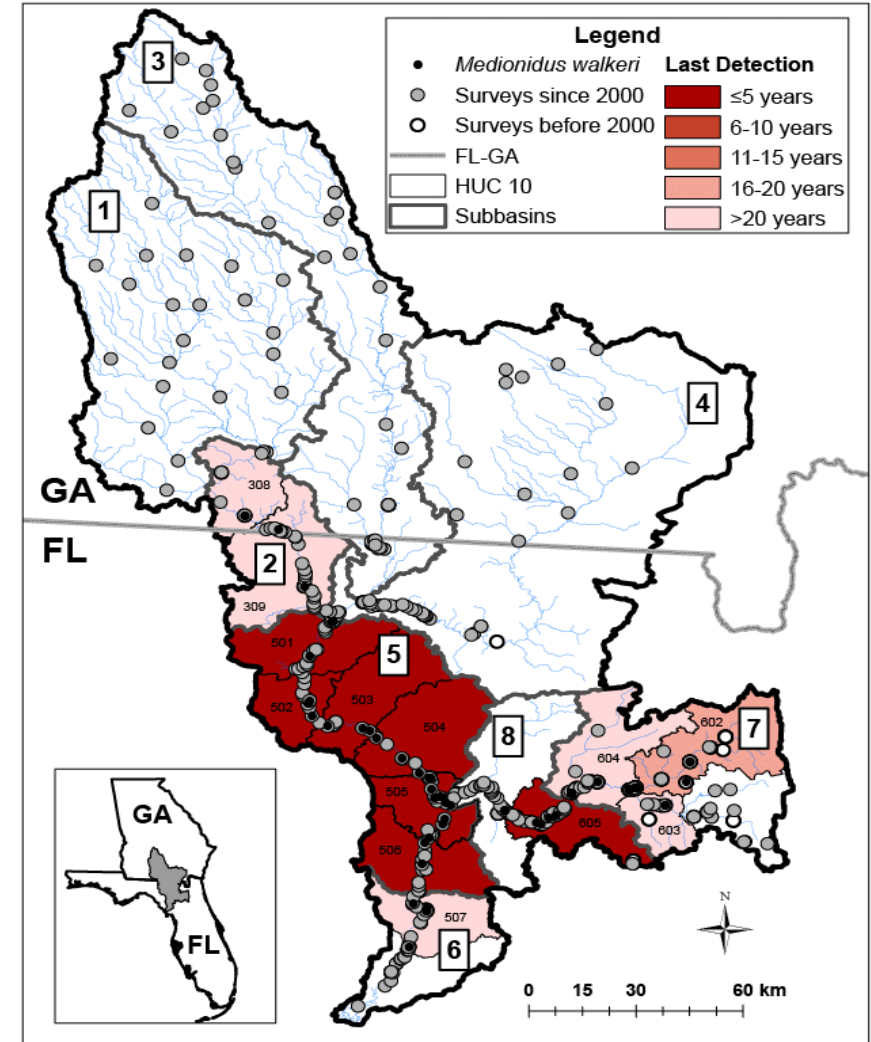

Suwannee Moccasinshell (*Medionidus walkeri*)

- Endemic species
- Unique distribution to where acidic, tannic colored streams meet alkaline spring waters
- IUCN listed as critically endangered; FWS status pending
- Extirpated from New River (last reported 1996)
- Susceptible to catastrophic events
- Abnormally low flow leads to high mussel mortality
- Reintroduction into Upper Sante Fe and New River **is** considered important to provide refugia, **which is** missing downstream in the Suwannee basin

Oval Pigtoe (*Pleurobema pyriforme*)

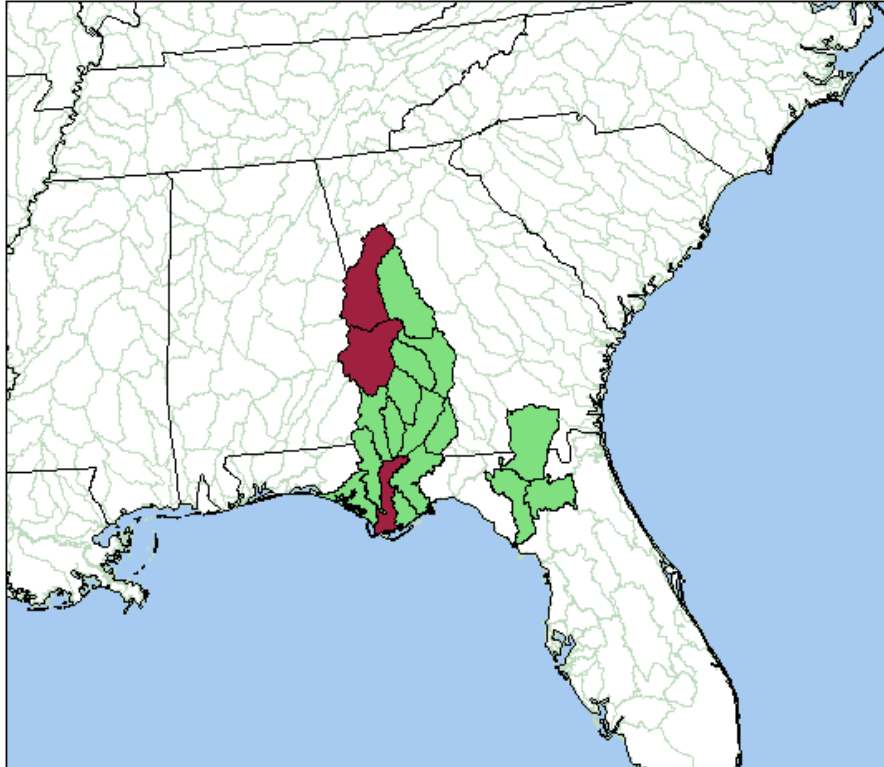
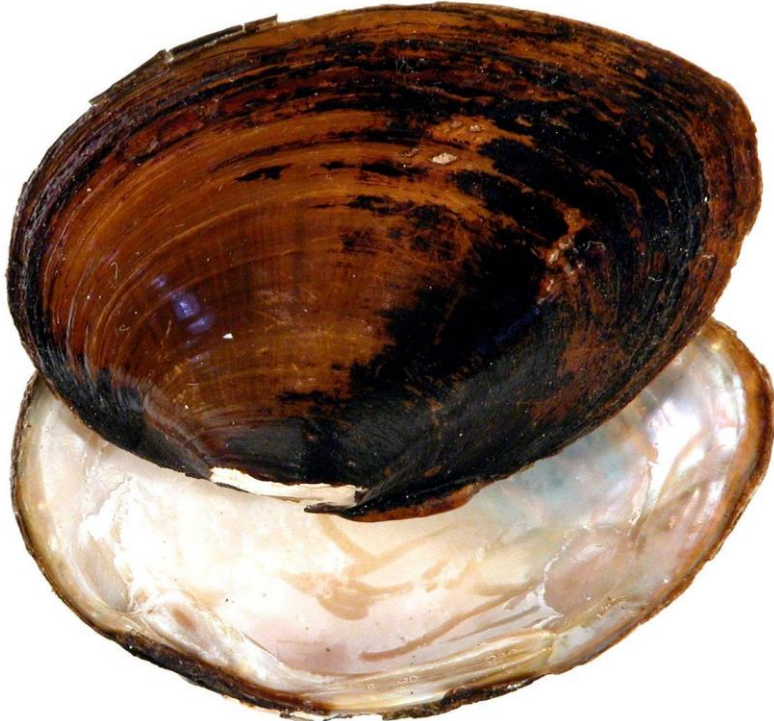

Pleurobema pyriforme
Oval Pigtoe

Map created April 2010

Administrative Boundary
Hydrological Unit
Current Distribution
Extrapolated/Possibly Extrapolated

100 0 100 Kilometers

NatureServe

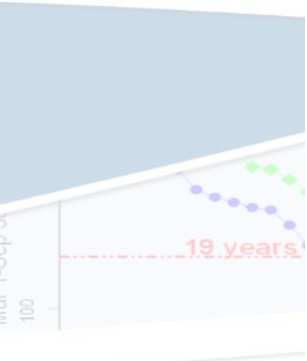

Oval Pigtoe (*Pleurobema pyriforme*)

- Endemic species feeding on organic matter suspended in water
- Slow-moderate flowing creeks and rivers with silty-sand to gravel
- Endangered: FWS, FWC, IUCN
- Populations declining significantly due to land use changes & development
- Dams reduce river flow, which causes sediment build up and burial of mussels
- New River is considered critical habitat (FWS)

Regionally Significant Mitigation Project 8/17

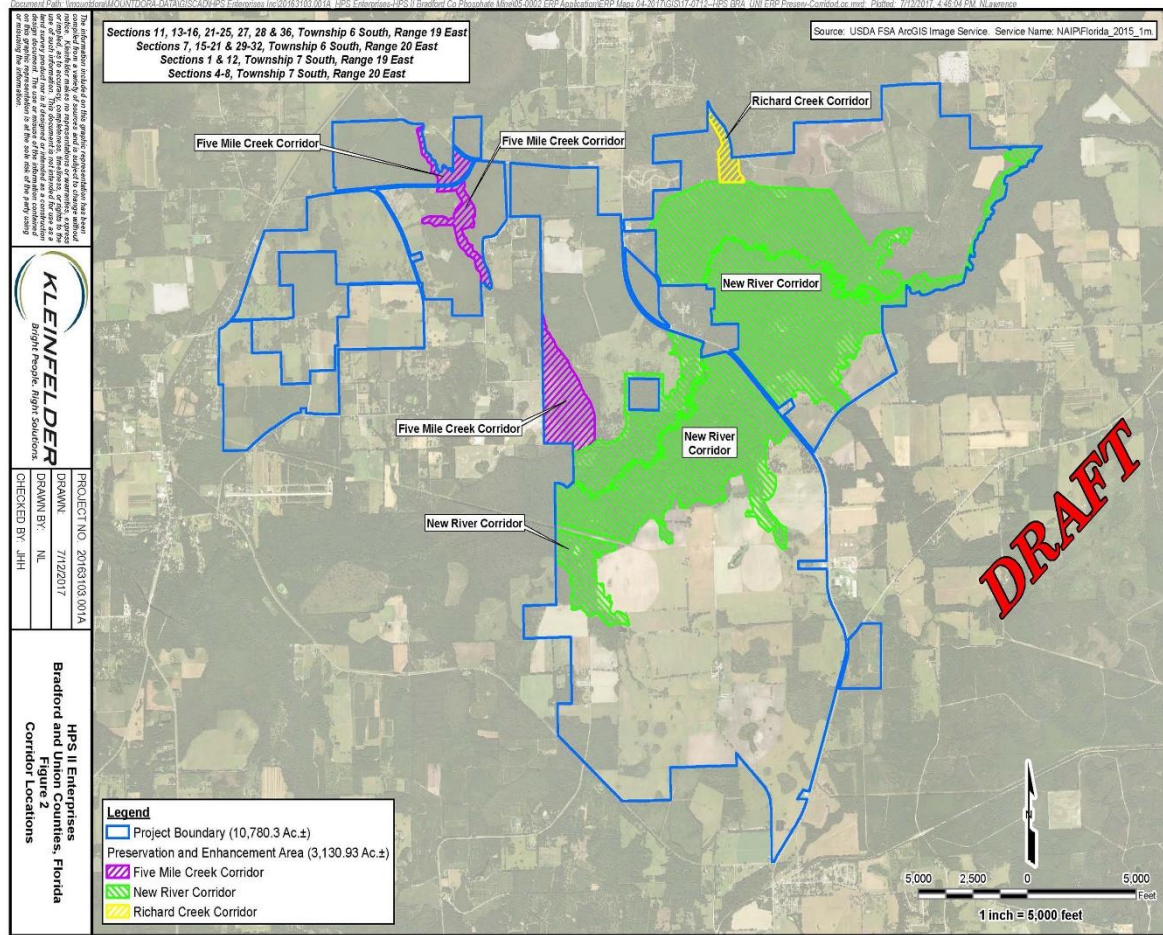

- Five Mile Creek Corridor
- New River Corridor
- Richard Creek Corridor



New River Corridor

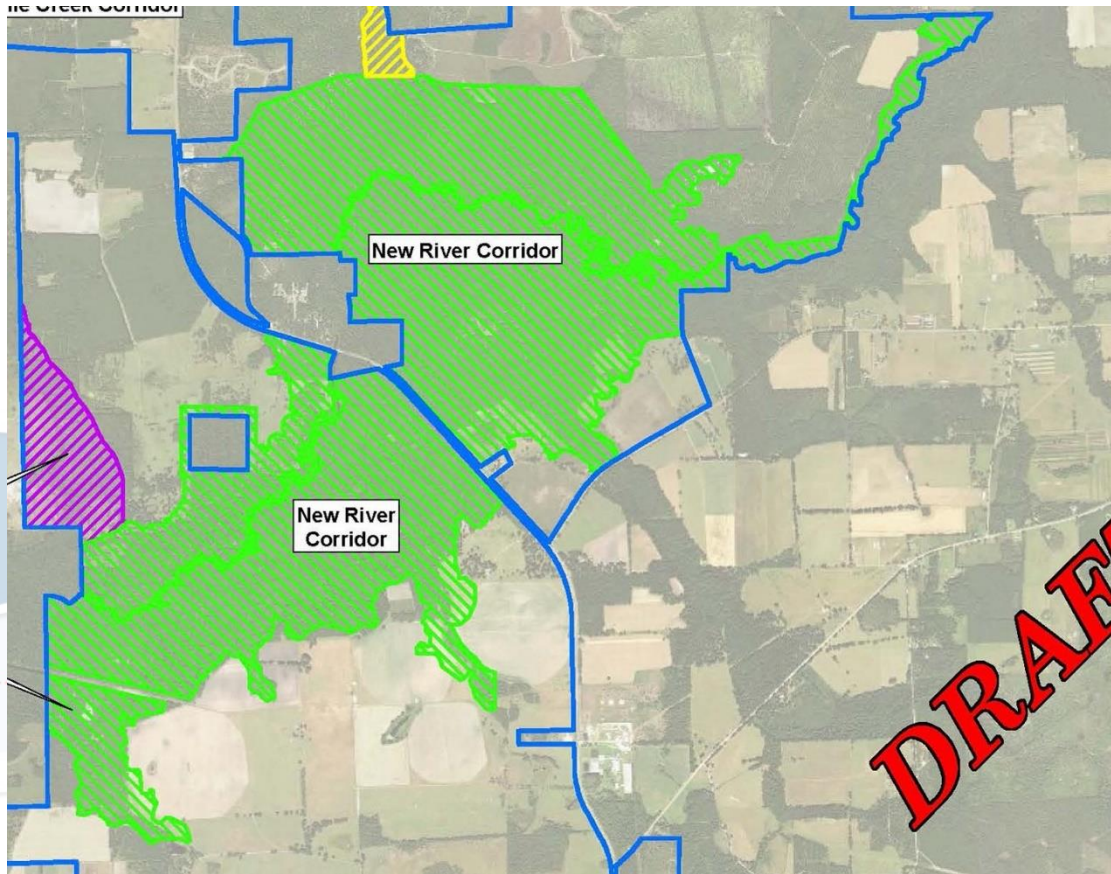

- Monitoring planned for 5 miles of New River within project area only
- NRC limited to river channel in places, especially to northeast
- Fill .38 acre cattle pond on floodplain without cause
- Berm removal at Five Mile Creek entry and another stream to encourage sheet flow

Richard Creek Corridor

- Northern portion perennial flow
- Southern portion loss of defined channel: a slough to New River
- No upland buffer along eastern stream bank

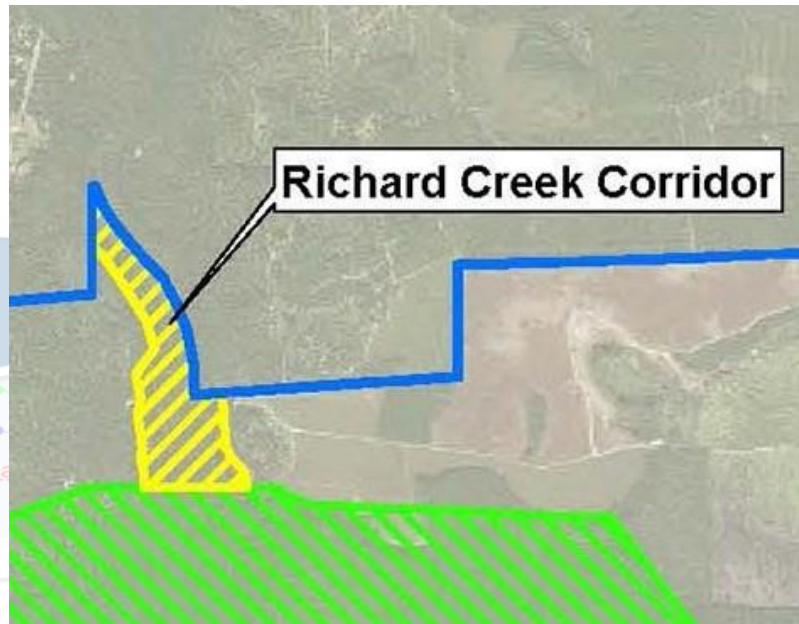

Five Mile Creek Corridor

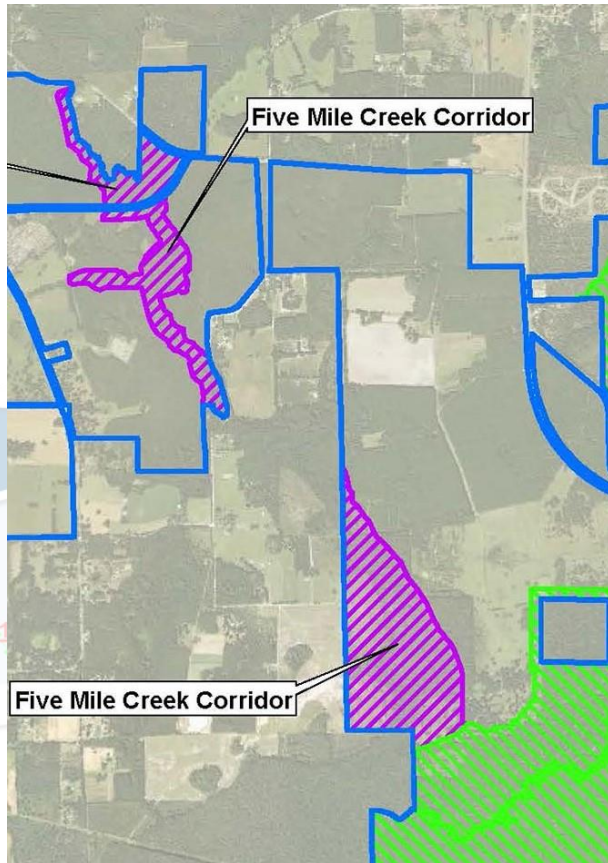

- North and South stream sections not connected with mitigation
- Little upland buffer zone
- Berm removal at boundary with New River Corridor

Regionally Significant Mitigation Project 8/17

- General Concerns:

- Barbed wire fencing throughout will hinder free movement of wildlife along New River Corridor
- Berm removal may increase sedimentation on NRC
- Only 1 monitoring site is shown on New River
- Reverse swales with 18 inch berm proposed to ring wetlands. Need evidence that this will stop overland flow as stated. Rationale for berm removal vs swale construction not given
- Throughout the three corridors, there are areas with little to no upland buffer
- Correction of channelized streams will be done indirectly with no active restoration planned
- Thinning of upland conifers should emphasize restoration of native pine flatlands.

Overall Concerns for Wetlands

- Loss of connection with river
- Loss of sediment trapping by floodplain
- Reproductive failure of select tree species via altered hydrology
- Reduction in level of colored water in New River will increase light for phytoplankton **growth in the river.** Increased symptoms of eutrophication

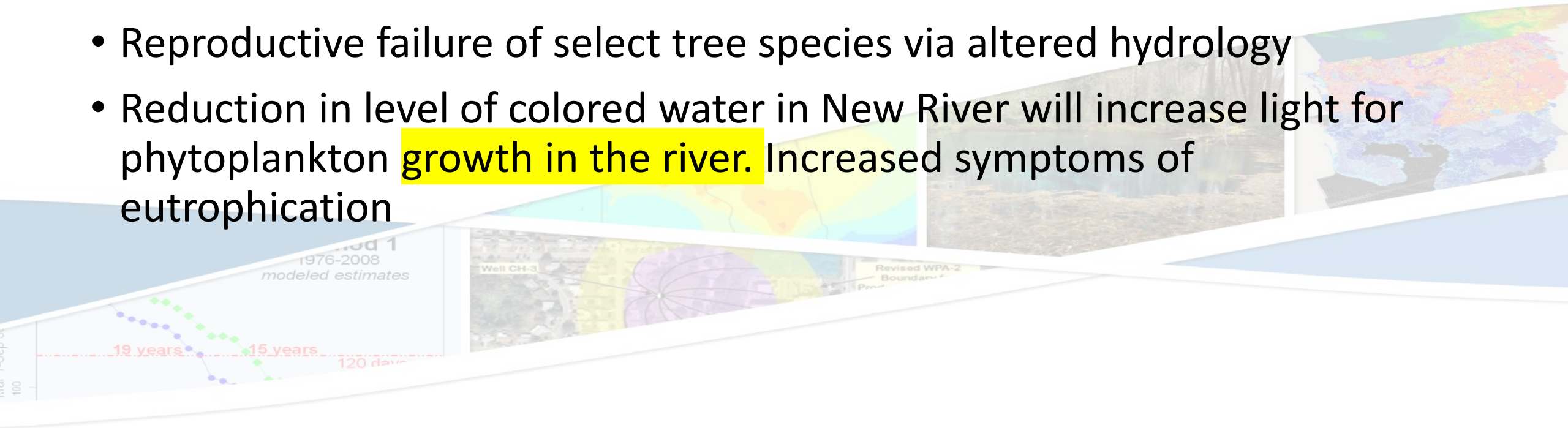

Thank you!

