



# ***Alachua County, FL***

## ***Joint Meeting***

---

### **Meeting Agenda - Final**

**Tuesday, May 19, 2020**

**3:00 PM**

**City of Gainesville**

Approval of items on the Consent Agenda are generally considered to be routine matters and the motion to adopt the Agenda approves all items on the Consent Agenda and is the first action taken by the Board at the beginning of the meeting. There will be no discussion on these items unless requested. Anyone wishing to speak to an item on the Consent Agenda may come forward and request the item be moved to the Regular Agenda prior to the approval of the agenda.

---

The Board of County Commissioners Regular Meeting offers an opportunity for public comment at 12:00 PM, 5:30 PM, prior to the final vote for each item, and at the end of the morning and evening meeting.

---

All persons are advised that, if they decide to contest any decision made at any of these meetings, they will need a record of the proceedings and, for such purpose they may need to ensure that verbatim record of the proceedings is made which record includes the testimony and evidence upon which the appeal is to be based. (Section 286.0105 Florida Statutes)

---

Pursuant to Ordinance 2014-11, Lobbyists are required to register for each employer on whose behalf he/she lobbies before the Board of County Commissioners prior to lobbying for that employer. For more information, visit <http://alachuacounty.us/Depts/Clerk/Pages/LobbyRegForm.aspx> or call 352-374-3605.

---

If you have a disability and need an accommodation in order to participate in this meeting, please contact the Alachua County Equal Opportunity Office at (352)374-5275 at least 2 business days prior to the meeting. TTY users please call 711 (Florida Relay Service).

---

Free parking is available for citizens attending this meeting. Please go to the Alachua County Manager's Office, located on the 2nd floor of the County Administration Building, for more information.

---

**Call To Order****Welcome****Introduction**

Mayor Lauren Poe, City of Gainesville

Chair Robert Hutchinson, Alachua County Commission

**Adoption of the Agenda****Items For Discussion**

1. [20-0370](#) COVID-19 Update: County and City Response and Recovery Efforts

*Fiscal Consideration:* N/A

*Recommended Action:* Have a discussion on COVID 19.

[FOR AGENDA 20-16 First Amendment Virtual Meetings.pdf](#)

[FOR AGENDA 20-21 First Amendment Alachua County Emergency Order.pdf](#)

[FOR AGENDA 20-23 Pools.pdf](#)

[120869\\_phase\\_1\\_safe\\_smart\\_step\\_by\\_step\\_plan\\_florida\\_s\\_recovery.pdf](#)

[Commissioner Cornell Email.msg](#)

[Commissioner Hutchinson email.pdf](#)

[Commissioner Byerly statement.docx](#)

[CDC face covering FAQ.pdf](#)

[DIY-cloth-face-covering-instructions.pdf](#)

[Johns Hopkins facial coverings.pdf](#)

[Mayo Clinic Masks.pdf](#)

[Face Masks for the General Public\\_Royal Society DELVE Initiative.pdf](#)

[COMMENTARY\\_Masks-for-all for COVID-19 not based on sound data\\_CIDRAP.pdf](#)

[EO-20-120 \(FAQs\).pdf](#)

[EO-20-120.pdf](#)

[EO 20-112 \(FAQs\).pdf](#)

[EO\\_20-112.pdf](#)

[EO 20-114.pdf](#)

2. [20-0406](#) Alachua County Sheriff's Office/Gainesville Joint Aviation Unit

*Fiscal Consideration:* TBD

*Recommended Action:* Have a discussion on a joint aviation unit.

**Public Comment****Commission General Comments and Information Discussion**

County Commission Comment

City Commission Comment

**Adjourn**



## Agenda Item Summary

---

Agenda Date: 5/19/2020

Agenda Item No.: 1.

---

**Agenda Item Name:**

COVID-19 Update: County and City Response and Recovery Efforts

**Presenter:**

Board of County Commissioners

**Description:**

Have a discussion.

**Recommended Action:**

Have a discussion on COVID 19.

**Prior Board Motions:**

May 5, 2020: Commissioner Byerly moved to direct staff to prepare for Board consideration at the next meeting a legal and procedural framework for the County to move forward with opening certain kinds of pools under certain conditions. The motion carried 5-0.

May 1, 2020:

- Add to the local order that to the extent there is a governing body or licensing group that imposes more stringent guidelines than OSHA then the business shall follow those guidelines. The motion carried 5-0.
- Authorize a Chair Letter to the Governor requesting to allow the permitting of non-essential manufacturing or other businesses that can identify and prove to the local jurisdiction that they qualify are low risk under the OSHA regulations and ask the Governor to permit the opening of passive parks and wildlife sanctuaries. The motion carried 5-0.
- Commissioner Byerly moved to follow the FDA best practices for restaurants in a Covid environment. The motion carried 5-0.
- Commissioner Byerly moved to follow the Governors order for retail/essential business changing the occupancy to 1 customer for 500 sq. ft. The motion carried 3-2 with Commissioner Cornell and Commissioner Chestnut voting "Nay".
- Commissioner Cornell moved the Board adopt the Miami Dade face covering emergency order 20-20 with the amendment of exempting restaurant patrons while dining. The motion carried 4-1 with Commissioner Byerly voting "Nay".

April 14, 2020: Commissioner Cornell moved to ratify the Emergency Order 2020-16. The motion carried 4-0 with Commissioner Chestnut out of the room.

**Fiscal Consideration:**

N/A

**Background:**

Please click here to view all Alachua County COVID-19 Emergency Orders:

[<https://alachuacounty.sharefile.com/d-sa87d17a87dc4c63b>](https://alachuacounty.sharefile.com/d-sa87d17a87dc4c63b)

Face Masks for the General Public, May 4, 2020,

[<https://rs-delve.github.io/reports/2020/05/04/face-masks-for-the-general-public.html>](https://rs-delve.github.io/reports/2020/05/04/face-masks-for-the-general-public.html)

Mayo Clinic: COVID-19: How much protection do face masks offer?

[<https://www.mayoclinic.org/diseases-conditions/coronavirus/in-depth/coronavirus-mask/art-20485449>](https://www.mayoclinic.org/diseases-conditions/coronavirus/in-depth/coronavirus-mask/art-20485449)

University of Minnesota: COMMENTARY: Masks-for-all for COVID-19 not based on sound data,

[<https://www.cidrap.umn.edu/news-perspective/2020/04/commentary-masks-all-covid-19-not-based-sound-data>](https://www.cidrap.umn.edu/news-perspective/2020/04/commentary-masks-all-covid-19-not-based-sound-data)

Johns Hopkins Medicine: Coronavirus Face Masks & Protection FAQs,

[<https://www.hopkinsmedicine.org/health/conditions-and-diseases/coronavirus/coronavirus-face-masks-what-you-need-to-know>](https://www.hopkinsmedicine.org/health/conditions-and-diseases/coronavirus/coronavirus-face-masks-what-you-need-to-know)

CDC: Cloth Face Coverings: Questions and Answers,

[<https://www.cdc.gov/coronavirus/2019-ncov/prevent-getting-sick/cloth-face-cover-faq.html>](https://www.cdc.gov/coronavirus/2019-ncov/prevent-getting-sick/cloth-face-cover-faq.html)

CDC: Use of Cloth Face Coverings to Help Slow the Spread of COVID-19,

[<https://www.cdc.gov/coronavirus/2019-ncov/prevent-getting-sick/diy-cloth-face-coverings.html>](https://www.cdc.gov/coronavirus/2019-ncov/prevent-getting-sick/diy-cloth-face-coverings.html)

**FIRST AMENDMENT TO EMERGENCY ORDER NO. 2020-16  
VIRTUAL GOVERNMENT IN THE SUNSHINE MEETINGS  
THROUGH THE USE OF COMMUNICATIONS MEDIA TECHNOLOGY**

**WHEREAS**, Alachua County is under Federal, State, and Local States of Emergency for the COVID-19 virus pursuant to Executive Orders of the Governor for the State of Florida (EO Nos. 20-51 and 20-52) and the Alachua County Proclamation 20-01, dated March 16, 2020, and renewed every seven days thereafter in accordance with law; and

**WHEREAS**, Chapter 252, Fla. Stat, and Section 27.03, Alachua County Code of Ordinances authorizes the County to take whatever prudent action is necessary to ensure the health, safety and welfare of the community in the event of a state of emergency; and

**WHEREAS**, to reduce the spread of COVID-19, the United States Centers for Disease Control and Prevention ("CDC") and the Florida State Department of Health recommend implementation of community mitigation strategies to increase containment of the virus, including cancellation of large gatherings and social distancing of at least six feet between persons in smaller gatherings; and,

**WHEREAS**, limitations on gatherings and the use of social distancing to prevent transmission of COVID-19 are especially important for people who are over sixty-five years old and people with chronic health conditions because those populations are at a higher risk of severe illness and death from COVID-19. However, it appears that everyone, regardless of age or health condition, is threatened by COVID-19; and,

**WHEREAS**, Article I, Section 24 of the Florida Constitution guarantees a right of public access to all meetings of any collegial public body of the County, and Section 286.011, Fla. Stat., commonly referred to as Florida's "Sunshine Law," requires meetings of the County to be publicly noticed in advance, open to the public, and documented by minutes that are promptly recorded; and

**WHEREAS**, the Sunshine Law is a polestar of local governance in Florida with the Florida Supreme Court stating that the Sunshine Law "was enacted in the public interest to protect the public from 'closed door' politics..." and as such, should be construed to frustrate all evasive devices; and

**WHEREAS**, recognizing the compelling need to protect life while at the same time maintaining the functioning and continuity of government, the Governor took the extraordinary measure of issuing Executive Order 20-69 ("EO 20-69"), which suspends any statutory requirement that local governing bodies have a quorum physically present in a specific public place to conduct public meetings; and

**WHEREAS**, the EO 20-69 specifically authorizes the use of communications media technology ("CMT"), as provided in Section 120.54(5)(b)2., Fla. Stat., to conduct meetings of local governing bodies; and

Alachua County  
First Amendment to Emergency Order 20-16

**WHEREAS**, Section 120.54(5)(b)2., Fla. Stat., may be interpreted to imply that local government bodies should provide, and publish notice of the location of, a communication media technology facility that may be used by those members of the public that wish to participate in such public meetings but do not have the communications media technology to do so; however, providing such a location, and encouraging members of the public to use said facility, would violate the spirit, intent and purpose of the Governor’s subsequent Executive Order (“EO 20-91”), which prohibits all persons in Florida from leaving their homes except to obtain or provide essential services or conduct essential activities; and

**WHEREAS**, Alachua County Emergency Order 20-10 specifically suspends any local law, ordinance, rule, charter provision or other regulations that requires a quorum to be physically present in a particular location, and authorizes the use of communications media technology for meetings of boards and committees; and

**WHEREAS**, the use of communications media technology during the declared state of local emergency due to COVID-19 to conduct meetings of the Board of County Commissioners and its boards and committees will allow governance to continue while protecting the health and safety of elected officials, staff, and the general public; and

**WHEREAS**, quasi-judicial hearings require that parties be afforded additional opportunities to participate in hearings beyond general public comment opportunities; and

**WHEREAS**, due process is an important aspect of quasi-judicial hearings to ensure that parties have a reasonable opportunity to submit evidence into the record for the consideration of the collegial board; and

**WHEREAS**, these rules provide an adequate avenue for the public to participate in public meetings and public hearings, including as parties to quasi-judicial matters; and

**WHEREAS**, the Governor issued EO-112, extending the use of CMT for public meetings and public hearings under EO 20-69 for the duration of EO-112; and

**WHEREAS**, neither EO 20-69 nor this Emergency Order suspend the requirements of Florida’s public records laws in any way or the Sunshine Law beyond the specific, discrete parameters explicitly set forth in EO 20-69 and this Emergency Order.

**THEREFORE, IT IS ORDERED THAT:**

**Section 1. Findings.** The above recitals are true and correct and are incorporated herein.

**Section 2. Emergency Order 20-16, Section 2, is hereby amended as follows:**

**Section 2 Applicability and Limitation.** This Emergency Order, and any amendments to this Emergency Order, shall apply to all meetings or public hearings of the Alachua County Board of County Commissioners, and its boards and committees which operate under the Sunshine Law. Public meetings and public hearings will comply with all requirements of Section 286.011, Fla. Stat., as well as all other requirements of law, which have not otherwise been suspended or waived pursuant to EO 20-69 or Emergency Order 20-16, including any amendments. Pursuant to EO 20-69 and Alachua County Emergency Order 20-10, any necessary quorum of the county government may be established by members attending the meeting through CMT means. CMT, for purposes of this Order, shall include, but is not limited to, electronic transmission of printed matter, audio, full-motion video, freeze-frame video, compressed video, and digital video which meets the intent of permitting attendance at public meetings.

**Section 3. Emergency Order 20-16 is hereby amended to include the following supplemental rules for quasi-judicial public hearings as Section 3(f) of Emergency Order 20-16:**

**f) Specific Rules for Quasi-Judicial Public Hearings**

**1. Notice of Electronic Quasi-Judicial Public Hearings**

The County will post notice of its electronic public meetings in a manner consistent with Section 286.011, Florida Statutes, and any other requirement of law not otherwise waived by the Governor's EO 20-69 or Alachua County Emergency order 20-16. Meeting notices will include instructions for interested members of the public to virtually attend via telephone, video conferencing or webinar technology utilized by the County. The notice shall also include a process for individuals or entities to participate in the quasi-judicial public hearing as parties if they feel that they meet the legal criteria for party status, including being more substantially affected by the application than the public at large.

**2. Request to Participate as a Party**

A. No later than 5 calendar days prior to the hearing, an individual or entity wishing to participate as a party in a quasi-judicial public hearing must provide the County with a written request to be considered as a party. The request must include a factual basis for why the requestor believes that he or she should be allowed to participate as a party.

B. Any individual or entity who wishes to participate as a party to the proceeding but is unable to attend the hearing through communication media technology (CMT), may request a reasonable accommodation to allow for participation in the public hearing. All requests for reasonable accommodation must be made in writing no later than 5 calendar days prior to the hearing.

C. At the outset of each quasi-judicial public hearing, the Board of County Commissioners, or quasi-judicial boards or committees operating under its authority, shall consider the written requests for party status and make a determination of whether a requesting individual or entity will be considered a party to the proceeding and allowed to participate as such.

### **3. Evidence**

A. Any evidence, testimony, argument, or other information offered utilizing CMT shall be afforded equal consideration as if it were offered in person and shall be subject to the same objections.

B. If an individual or entity intends to participate as a party and provide evidence, beyond testimony, at the public hearing, the individual or entity must provide electronic copies of all evidence to the Clerk or appropriate County staff no later than 3 calendar days prior to the hearing. Any evidence provided electronically will be entered into the record and provided to all identified parties, even if the evidence is provided by a non-party participant.

C. Witnesses are not required to be physically present to be sworn and may be sworn and testify through CMT. To the extent possible by CMT, testimony and evidence of recognized parties will be subject to reasonable cross-examination by other parties to the proceeding.

D. Parties will be provided a maximum of 15 minutes to make argument, testify, and present relevant evidence at the quasi-judicial public hearing. The Chair may grant additional time for complex matters if the party needs additional time to provide relevant, non-repetitious, non-slanderous testimony or evidence. The Chair may also grant additional time to a party to allow for questions from the Board or committee hearing the item.

E. Testimony and evidence offered during regular public comment on a quasi-judicial item will be considered and entered into the record of the decision.

### **4. Applicant Waivers for Quasi-Judicial Items**

For quasi-judicial agenda items, applicants who elect to have their items considered at a CMT public hearing shall pay the cost to advertise the item and shall agree to waive the right to challenge the validity, adequacy, or constitutionality of the rules and procedures set forth in this Order or of the CMT proceeding. Such waivers shall be provided in writing in advance of the CMT meeting. Quasi-judicial applicants that do not provide such waivers shall be continued to the next available hearing that does not utilize CMT. In addition, the County reserves the right to continue any quasi-judicial item that the County Manager or Board of County Commissioners determines is not appropriate to be conducted through CMT, even if the applicant provides the required waivers.



**5. Conduct of the Public Hearing**

A. In order to ensure that all speakers at the CMT proceeding are properly recorded, all speakers at the CMT public hearing must be recognized by the Chair prior to speaking, and no more than one person shall speak at the same time. All votes on all action items shall be by roll call vote.

B. The Chair of the Board of County Commissioners, or of any board or committee acting under its authority, may limit testimony or the presentation of evidence, including from recognized parties in quasi-judicial public hearings, if the testimony or evidence is repetitious, immaterial, or slanderous.

**6. General Provisions**

All other general provisions of Alachua County Emergency Order 20-16 shall apply to the conduct of quasi-judicial public hearings.

**Section 4. Effective Date and Termination.**

This First Amendment to Emergency Order 20-16 will take effect upon filing with the Clerk of Courts of Alachua County in accordance with Section 252.46(2), Fla. Stat., and shall remain in effect until modified or terminated by subsequent order or until the Executive Order 20-69 expires or is rescinded.

Dated this 4th day of May, 2020 at 4:40 p.m.

BOARD OF COUNTY COMMISSIONERS  
OF ALACHUA COUNTY, FLORIDA

By:   
Robert Hutchinson, Chairman

APPROVED AS TO FORM:



County Attorney's Office

**FIRST AMENDMENT TO EMERGENCY ORDER NO. 2020-21**  
**PHASE ONE STEP BY STEP RECOVERY ORDER**  
**ALACHUA COUNTY, FLORIDA**

WHEREAS, COVID-19, a respiratory illness caused by a virus that spreads rapidly from person to person and may result in serious illness or death, constitutes a clear and present threat to the lives, health, welfare, and safety of the people of Alachua County; and,

WHEREAS, on March 1, 2020, Governor DeSantis declared a Public Health Emergency because of COVID-19; and, on March 9, 2020, Governor DeSantis issued Executive Order 20-52, declaring a State of Emergency because of COVID-19; and,

WHEREAS, on March 11, 2020, the World Health Organization declared the spread of COVID-19 to be a global pandemic; and, on March 13, 2020, President Trump declared a national emergency concerning COVID-19; and,

WHEREAS, Emergency Order 2020-01 declared a local state of emergency in Alachua County based on the COVID-19 virus on March 16, 2020; and,

WHEREAS, on March 17, 2020, Governor DeSantis issued Executive Order 20-68, prohibiting the sale of alcoholic beverages at certain establishments and placing certain limitations on gatherings for bars, restaurants, and beaches; and,

WHEREAS, to reduce the spread of COVID-19, the United States Centers for Disease Control and Prevention ("CDC") and the Florida State Department of Health recommend implementation of community mitigation strategies to increase containment of the virus, including cancellation of large gatherings and social distancing of at least six feet between persons in smaller gatherings; and,

WHEREAS, limitations on gatherings and the use of social distancing to prevent transmission of COVID-19 are especially important for people who are over sixty years old and people with chronic health conditions because those populations are at a higher risk of severe illness and death from COVID-19. However, everyone, regardless of age or health condition, is threatened by COVID-19; and,

WHEREAS, this Emergency Order is necessary to ensure that our healthcare delivery system can serve those who are ill; and

WHEREAS, the continuing operation of essential businesses is necessary to provide essential goods and services to the public; and,

WHEREAS, on April 1, 2020 Governor DeSantis issued Executive Order 20-91 putting in place a state-wide stay at home order and listing what are to be considered essential services and activities; and

WHEREAS, Executive Order 20-91 adopts both the Essential Critical Infrastructure Workers guidelines issued by the Department of Homeland Security and the list of essential services and activities set forth in Miami-Dade County Emergency Order 07-20; and,

WHEREAS, the CDC, the Florida Department of Health and the University of Florida

Alachua County  
First Amendment to Emergency Order 20-21

recommends the use of face coverings, including those which are homemade to slow the spread of the disease; and

WHEREAS, the gradual reopening of the State and the County will lead to more contact between individuals and lead to more potential for the increased community spread of the disease. Face masks are of great assistance in preventing individuals who may be shedding the virus to spread it to other individuals; and

WHEREAS, researchers at the University of Florida believe it is too early to ease restrictions without enhanced testing in place and that such testing is not currently in place and that COVID-19 will be present in the population for a long time <https://mediasite.video.ufl.edu/Mediasite/Play/b8849c7ddb114f2db5fcc0be6a4ec0b41d>; and,

WHEREAS, according to the Department of Health 7,174 out of 269,043 residents or 2.66% have been tested therefore, local testing has been underutilized and the number of individuals being tested needs to increase and contact tracing must increase as well; and

WHEREAS, COVID-19 is spread through airborne transmission from individuals sneezing, speaking and coughing and infectious droplet nuclei can spread for a great distance, although how far is not fully understood at present; and

WHEREAS, the Centers for Disease Control have recommended the use of facial coverings to reduce the spread of the virus since many individuals with no symptoms can spread the virus, <https://www.cdc.gov/coronavirus/2019-ncov/prevent-getting-sick/diy-cloth-face-coverings.html>; and

WHEREAS, Governor DeSantis has issued Executive Order 20-112 designed to ease some restrictions established by Executive Order 20-90 in the first phase of a plan to fully reopen the State; and

WHEREAS, Executive Order 20-112, does not preempt the authority of local governments to add additional restrictions to businesses opened by the Governor; and

WHEREAS, the Board of County Commissioners met on May 1<sup>st</sup> in special session to consider the Governor's Order and to receive public comment, and

WHEREAS, the Board of County Commissioners considered the public comment along with information received from the Department of Health and the University of Florida regarding challenges raised at this point in time by COVID-19; and

WHEREAS, the Board of County Commissioners believes based upon the foregoing that it is important to be cautious in the process of opening up businesses in the absence of detailed testing and contact testing while implementing the Governor's plan in phasing, reopening as local conditions allow to be done with prudence; and,

Alachua County  
First Amendment to Emergency Order 20-21

WHEREAS, the Chair of the County Commission is the Official Authority as prescribed in the County's Code Section 27.07; and,

WHEREAS, acting on his own authority as the Official Authority and based upon the actions taken on May 1<sup>st</sup> by the Board of County Commissioners meeting in public session; and

WHEREAS, pursuant to §252.38(1), Florida Statutes the County has jurisdictional authority over the entire county.

THEREFORE, IT IS ORDERED THAT:

1. While Executive Order 20-112 provides more opportunity to be outside the home, those who are vulnerable to infection should stay home as much as possible. Those who are not considered to be at risk should use prudence when leaving their home and stay at home if possible.
2. Pursuant to Executive Order 20-112, Essential Services and Activities are those set out in the CISA guidance and Executive Order 20-89 and a list propounded by Miami-Dade County in its Emergency Order 07-20. As stated in Order 20-91, this list is subject to change and an updated list may be found at [www.floridadisaster.org](http://www.floridadisaster.org). Private museums, libraries, botanical gardens and wildlife preserves may reopen at 25% of their capacity, but shall not allow any use of interactive displays or playground equipment.
3. All places of public assembly are closed to the public. Whether indoors or outdoors, including but not limited to, locations with amusement rides, carnivals, water parks, pools, zoos, arcades, fairs, children's play centers, playgrounds, theme parks, bowling alleys, pool halls, movie and other theaters, concert and music halls, country clubs, social clubs and fraternal organizations. To the extent any of these businesses have retail sales facilities as part of their operation, they may open subject to the limitations below and calculating occupancy based upon the retail space.
4. All Essential Services and Activities are encouraged to remain open. To the greatest extent feasible, Essential Services and Activities should comply with Social Distancing Requirements as recommended by the Centers for Disease Control and the Surgeon General of Florida, including by maintaining six-foot distance between both employees and members of the public always, including when any customers are standing in line. Pursuant to the Governor's Executive Order 20-83, and the Surgeon General's Health Advisory, employers should make every effort to reduce the onsite workforce to 50% capacity, where possible, to the extent that reduction can be accomplished without significantly disrupting the ability to conduct business. OSHA guidelines regarding COVID-19 found in publication 3990 shall be followed. <https://www.osha.gov/Publications/OSHA3990.pdf> or subsequent rules. Workers shall be educated by employers of the standards and require that standards be present on worksite. If an employee believes that they are being required to work in sub-standard conditions they may call the County's 311 phone number and leave a complaint anonymously. To the extent that there is an industry association, governing body, or licensure agency that imposes more stringent guidelines than OSHA, then the business shall comply with those requirements.

Alachua County  
First Amendment to Emergency Order 20-21

5. Pursuant to Executive Order 20-112, retail businesses may now open subject to the limitations in that order. Retail businesses are encouraged to utilize curbside service and via delivery to limit face to face contact. All businesses which are open, retail or otherwise, shall comply with the safety guidelines established by the CDC and OSHA. To the extent any business is governed by licensure or board requirements which are stricter than those of the CDC or OSHA, those board requirements will take precedence. A list will be developed covering Industry Specific Operating Standards for Pandemic Response which will be the standard used for enforcement.
6. In addition to the restrictions set forth in Executive 20-112, restaurants and food service facilities shall comply with the Food and Drug Administration "Best Practices for Retail Food Stores, Restaurants, and Food Pick Up and Delivery Services During the Covid-19 Pandemic."
7. Essential Services and Activities, and retail establishments shall limit occupancy, to one per five hundred square feet of covered space. In no case does this allow more than Executive Order 20-112. The business shall also be responsible for ensuring that appropriate social distancing be followed. Restaurants may open at 25% occupancy but, as set forth in the Governor's Executive Order 20-112, must follow appropriate social distancing in seating. Outdoor seating does not count against indoor occupancy but must meet the requirements of social distancing set forth in the Governor's Executive Order 20-112. The occupancy limits, for purposes of the one per five hundred square feet of covered space standard, do not include members of staff as long as they are able to comply with appropriate social distancing techniques under the circumstances. The limitations regarding essential services do not apply to Hospitals or other medical facilities following appropriate use of PPE as required by their licensing bodies. Child care facilities may use reasonable occupancy limits as allowed by their license and their ability to use PPE on the part of staff and after screening the children for at risk exposure.
8. Use of face coverings and personal protective equipment
  - a. Persons working in or visiting grocery stores, restaurants, retail facilities, pharmacies, construction sites, public transit vehicles, vehicles for hire, along with locations where social distancing measures are not possible shall wear facial coverings as defined by the CDC.
  - b. Face covering includes any covering which snugly covers the nose and mouth, whether store bought or homemade, and which is secured with ties or ear loops. Examples of compliant home-made masks may be found at <https://www.cdc.gov/coronavirus/2019ncov/prevent-getting-sick/diy-cloth-face-coverings.html>. Persons should not utilize N95 rated masks, as those are critical supplies for health care workers, police, fire, emergency management, or other persons engaged in life/safety activities. Persons who wear face coverings should review the CDC and Florida Department of Health guidelines regarding safely applying, removing, and cleaning face coverings.
  - c. A face covering shall not be required for children under six, persons who have trouble breathing due to a chronic pre-existing condition or individuals with a documented or demonstrable medical problem.
  - d. This Order does not change or alter any social distancing requirements imposed by this or in any other Emergency Order.
  - e. Face masks do not have to be worn while eating or drinking.

Alachua County  
First Amendment to Emergency Order 20-21

9. Pursuant to the Governor's Executive Order 20-91, no public gathering of 10 or more persons is allowed. Pursuant to the Order, groups greater than 10 may be ordered to disperse. This includes any gathering which takes place in the commons area of any multiple residence facility.

10. Severability.

Any provision(s) within this Emergency Order that conflict(s) with any State or Federal law or constitutional provision, including the State's preemption of the regulation of firearms and ammunition codified in section 790.33, Florida Statutes or conflict(s) with or are superseded by a current or subsequently-issued Executive Order of the Governor or the President of the United States, shall be deemed inapplicable and deemed to be severed from this Emergency Order, with the remainder of the Emergency Order remaining intact and in full force and effect. To the extent application of some or all the provisions of this Emergency Order is prohibited on the sovereign land of a federally or state recognized sovereign Indian tribe, such application is expressly excluded from this Emergency Order.

11 Effective Date; Duration.

This Order supersedes Emergency Order 20-09. This Order shall be effective May 5<sup>th</sup>, 2020 at 12:01 a.m. and will stay in effect during the pendency of the state of emergency or until adoption of subsequent order or repeal.

12. This Emergency Order is in addition to the Executive Orders issued by Governor DeSantis, including Emergency Orders 20-70 and 20-71.

13. This Emergency Order applies to incorporated and unincorporated areas within Alachua County, but has no application outside of Alachua County. Municipalities have the authority to enforce this County Order within their jurisdiction.

14 The County or municipalities within its boundaries will direct any establishment to cease and desist operations that are in violation of this Emergency Order and may treat violations as a violation of County or Municipal ordinance as appropriate. The County has jurisdiction countywide to enforce the terms of this Order.

15. This Order does not apply to operations of local governments within the county, to the State University System, State College System, the State of Florida, or Federal agencies who are encouraged to adopt their own rules and procedures regarding the matters set forth herein.

16. Any violation of these emergency measure(s) shall be a violation of §252.50, Florida Statutes and may be punishable as provided therein and shall be enforced by law enforcement as provided by law. For failure to wear face coverings in compliance with this Order, the County or municipalities within their jurisdictions will direct any individual acting in violation of this Emergency Order to come into compliance immediately. Failure to comply with the requirements of section 8 of this Emergency Order presents a serious threat to the public health, safety, and welfare, pursuant to Chapter 162, Florida Statutes, and a citation may be issued immediately for such violation. The first violation of section 8 of this Emergency Order shall be subject to a fine of \$125.00 to the violator. The second violation of section 8 of this Emergency Order shall be subject to a fine of \$250.00 to the violator. All

Alachua County  
First Amendment to Emergency Order 20-21

subsequent violations of section 8 of this Order shall constitute a Class V violation under Article II, Chapter 24 of the Alachua County Code of Ordinances, requiring a mandatory court appearance and subject to a fine not to exceed \$500.00. All other remedies available at law or equity, including injunction, remain available to the County, even after issuance of a citation.

17. This Order supersedes and replaces any conflicting provisions of prior orders.

Dated this 4th day of May, 2020 at 7:05 p.m.

BOARD OF COUNTY COMMISSIONERS  
OF ALACHUA COUNTY, FLORIDA

By:   
Robert Hutchinson, Chairman

APPROVED AS TO FORM:

  
\_\_\_\_\_

County Attorney's Office

**EMERGENCY ORDER NO. 2020-23**  
**LIMITED REOPENING OF PUBLIC POOLS**  
**ALACHUA COUNTY, FLORIDA**

WHEREAS, COVID-19, a respiratory illness caused by a virus that spreads rapidly from person to person and may result in serious illness or death, constitutes a clear and present threat to the lives, health, welfare, and safety of the people of Alachua County; and,

WHEREAS, on March 1, 2020, Governor DeSantis declared a Public Health Emergency because of COVID-19; and, on March 9, 2020, Governor DeSantis issued Executive Order 20-52, declaring a State of Emergency because of COVID-19; and,

WHEREAS, on March 11, 2020, the World Health Organization declared the spread of COVID-19 to be a global pandemic; and, on March 13, 2020, President Trump declared a national emergency concerning COVID-19; and,

WHEREAS, Emergency Order 2020-01 declared a local state of emergency in Alachua County based on the COVID-19 virus on March 16, 2020; and,

WHEREAS, on March 17, 2020, Governor DeSantis issued Executive Order 20-68, prohibiting the sale of alcoholic beverages at certain establishments and placing certain limitations on gatherings for bars, restaurants, and beaches; and,

WHEREAS, to reduce the spread of COVID-19, the United States Centers for Disease Control and Prevention ("CDC") and the Florida State Department of Health recommend implementation of community mitigation strategies to increase containment of the virus, including cancellation of large gatherings and social distancing of at least six feet between persons in smaller gatherings; and,

WHEREAS, limitations on gatherings and the use of social distancing to prevent transmission of COVID-19 are especially important for people who are over sixty years old and people with chronic health conditions because those populations are at a higher risk of severe illness and death from COVID-19. However, everyone, regardless of age or health condition, is threatened by COVID-19; and,

WHEREAS, this Emergency Order is necessary to ensure that our healthcare delivery system can serve those who are ill; and

WHEREAS, the continuing operation of essential businesses is necessary to provide essential goods and services to the public; and,

WHEREAS, on April 1, 2020 Governor DeSantis issued Executive Order 20-91 putting in place a state-wide stay at home order and listing what are to be considered essential services and activities; and

WHEREAS, Executive Order 20-91 adopts both the Essential Critical Infrastructure Workers guidelines issued by the Department of Homeland Security and the list of essential services and activities set forth in Miami-Dade County Emergency Order 07-20; and,

WHEREAS, the CDC, the Florida Department of Health and the University of Florida recommends the use of face masks, even those which are homemade to slow the spread of the



Alachua County  
Emergency Order 20-23

disease; and

WHEREAS, the gradual reopening of the State and the County will lead to more contact between individuals and lead to more potential for the increased community spread of the disease. Face masks are of great assistance in preventing individuals who may be shedding the virus to spread it to other individuals; and

WHEREAS, Executive Order 20-112, does not preempt the authority of local governments to add additional restrictions to businesses opened by the Governor; and

WHEREAS, Executive Order 20-91 provided that recreation such as swimming was allowed; and

WHEREAS, Emergency Order 2020-21 provides that pools are currently closed; and

WHEREAS, the Board of County Commissioners met on May 1<sup>st</sup> in special session to consider the Governor's Order and to receive public comment, and

WHEREAS, the Board of County Commissioners considered the public comment along with information received from the Department of Health and the public over the use of pools when properly operated and that properly treated water will not spread the COVID-19 virus; and

WHEREAS, the Board of County Commissioners believes based upon the foregoing that it is appropriate to open up pools for certain uses; and,

WHEREAS, the Chair of the County Commission is the Official Authority as prescribed in the County's Code Section 27.07; and,

WHEREAS, acting on his authority as the Official Authority and based upon the actions taken on May 1<sup>st</sup> by the Board of County Commissioners; and

WHEREAS, Pursuant to §252.38(1), Florida Statutes the County shall have jurisdictional authority over the entire county.

THEREFORE, IT IS ORDERED THAT:

1. Outside pools which are open to the public and those which are part of multi-family residential communities may reopen.
2. The pools shall meet the standards set by the CDC <https://www.cdc.gov/healthywater/swimming/index.html> and Florida Administrative Code §64E-9.004 for disinfectant level.
3. All seating and tables around any pool shall be set up with social distancing of at least 6 feet between groupings and fixed in some way so they cannot be easily rearranged.
4. Activity in pools shall be limited to activities with social distancing and occupancy of 1 person per 100 square feet of water surface. Groupings outside the pool shall be

Alachua County  
Emergency Order 20-23

limited to no more than 10 individuals.

5. The owners/operators of these pools shall post signs explaining these rules and monitor the pool for compliance with the health standards and use limitations on a reasonable basis.
6. Pool houses and locker rooms must limit their occupancy to 1 person per 500 square feet and shall ensure that surfaces within businesses are disinfected in accordance with applicable CDC guidelines. Employees working in pool houses, locker rooms, around pools and in similar areas shall wear facial coverings.
7. Severability. Any provision(s) within this Emergency Order that conflict(s) with any State or Federal law or constitutional provision, including the State's preemption of the regulation of firearms and ammunition codified in section 790.33, Florida Statutes or conflict(s) with or are superseded by a current or subsequently-issued Executive Order of the Governor or the President of the United States, shall be deemed inapplicable and deemed to be severed from this Emergency Order, with the remainder of the Emergency Order remaining intact and in full force and effect. To the extent application of some or all the provisions of this Emergency Order is prohibited on the sovereign land of a federally or state recognized sovereign Indian tribe, such application is expressly excluded from this Emergency Order.
8. Effective Date; This Order takes effect at 12:01 a.m. on 5/9/20.
9. This Emergency Order applies to incorporated and unincorporated areas within Alachua County, but has no application outside of Alachua County. Municipalities have the authority to enforce this Order within their jurisdiction.
10. The County or municipalities within its boundaries will direct any establishment to cease and desist operations that are in violation of this Emergency Order and may treat violations as a violation of County or Municipal ordinance as appropriate. The County has jurisdiction countywide to enforce the terms of this Order.
11. This Order does not apply to operations of local governments within the county, to the State University System, State College System, the State of Florida, or Federal agencies who are encouraged to adopt their own rules and procedures regarding the matters set forth herein.
11. This Order supersedes and replaces any conflicting provisions of prior orders.

Dated this 8th day of May, 2020 at 7:00 p.m.

BOARD OF COUNTY COMMISSIONERS  
OF ALACHUA COUNTY, FLORIDA

By:   
Robert Hutchinson, Chairman

APPROVED AS TO FORM:



---

County Attorney's Office

# STATE OF FLORIDA

## OFFICE OF THE GOVERNOR

### EXECUTIVE ORDER NUMBER 20-112

(Phase 1: Safe. Smart. Step-by-Step. Plan for Florida's Recovery)

**WHEREAS**, on March 9, 2020, I issued Executive Order 20-52 declaring a state of emergency for the entire State of Florida as a result of COVID-19; and

**WHEREAS**, on April 3, 2020, I issued Executive Order 20-91 and Executive Order 20-92 directing all persons in Florida to limit their movements and personal interactions outside of their home only to those necessary to obtain or provide essential services or conduct essential activities; and

**WHEREAS**, my administration has implemented a data-driven strategy devoted to high-volume testing and aggressive contact tracing, as well as strict screening protocols in long-term care facilities to protect vulnerable residents; and

**WHEREAS**, data collected by the Florida Department of Health indicates the State has achieved several critical benchmarks in flattening the curve, including a downward trajectory of hospital visits for influenza-like illness and COVID-19-like syndromic cases, a decrease in percent positive test results, and a significant increase in hospital capacity since March 1, 2020; and

**WHEREAS**, during the week of April 20, 2020, I convened the Task Force to Re-Open Florida to evaluate how to safely and strategically re-open the State; and

**WHEREAS**, the path to re-opening Florida must promote business operation and economic recovery while maintaining focus on core safety principles.

**NOW, THEREFORE, I, RON DESANTIS**, as Governor of Florida, by virtue of the authority vested in me by Article IV, Section (1)(a) of the Florida Constitution and Chapter 252, Florida Statutes, and all other applicable laws, promulgate the following Executive Order:

Section 1. Phase 1 Recovery

In concert with the efforts of President Donald J. Trump and the White House Coronavirus Task Force, and based on guidance provided by the White House and the Centers for Disease Control and Prevention (CDC), the Occupational Safety and Health Administration (OSHA), and the Florida Surgeon General and State Health Officer, Dr. Scott Rivkees, I hereby adopt the following in response to the recommendations in Phase 1 of the plan published by the Task Force to Re-Open Florida.

Section 2. Responsible Individual Activity

A. All persons in Florida shall continue to limit their personal interactions outside the home; however, as of the effective date of this order, persons in Florida may provide or obtain:

1. All services and activities currently allowed, *i.e.*, those described in Executive Order 20-91 and its attachments, which include activities detailed in Section 3 of Executive Order 20-91, the U.S. Department of Homeland Security in its Guidance on the Essential Critical Infrastructure Workforce and a list propounded by Miami-Dade County in multiple orders (as of April 1, 2020), as well as other services and activities approved by the State Coordinating Officer. Such services should continue to follow safety

guidelines issued by the CDC and OSHA. If necessary, employee screening or use of personal protective equipment should continue.

2. Additional services responsibly provided in accordance with Sections 3 and 4 of this order in counties other than Miami-Dade, Broward and Palm Beach. In Miami-Dade, Broward and Palm Beach counties, allowances for services and activities from Sections 3 and 4 of this order will be considered in consultation with local leadership.

B. Except as provided in Section 2(A)(1) of this order, senior citizens and individuals with a significant underlying medical condition (such as chronic lung disease, moderate-to-severe asthma, serious heart conditions, immunocompromised status, cancer, diabetes, severe obesity, renal failure and liver disease) are strongly encouraged to stay at home and take all measures to limit the risk of exposure to COVID-19.

C. For the duration of this order, all persons in Florida should:

1. Avoid congregating in large groups. Local jurisdictions shall ensure that groups of people greater than ten are not permitted to congregate in any public space that does not readily allow for appropriate physical distancing.
2. Avoid nonessential travel, including to U.S. states and cities outside of Florida with a significant presence of COVID-19.
3. Adhere to guidelines from the CDC regarding isolation for 14 days following travel on a cruise or from any international destination and any area with a significant presence of COVID-19.

D. This order extends Executive Order 20-80 (Airport Screening and Isolation) and Executive Order 20-82 (Isolation of Individuals Traveling to Florida), with exceptions for persons involved in military, emergency, health or infrastructure response or involved in commercial activity. This order extends Sections 1(C) and 1(D) of Executive Order 20-86 (Additional Requirements of Certain Individuals Traveling to Florida), which authorize the Department of Transportation, with assistance from the Florida Highway Patrol and county sheriffs, to continue to implement checkpoints on roadways as necessary.

Section 3. Businesses Restricted by Previous Executive Orders

Unless I direct otherwise, for the duration of this order, the following applies to businesses directly addressed by my previous Executive Orders:

- A. Bars, pubs and nightclubs that derive more than 50 percent of gross revenue from the sale of alcoholic beverages shall continue to suspend the sale of alcoholic beverages for on-premises consumption. This provision extends Executive Order 20-68, Section 1 as modified by Executive Order 20-71, Sections 1 and 2.
- B. Restaurants and food establishments licensed under Chapters 500 or 509, Florida Statutes, may allow on-premises consumption of food and beverage, so long as they adopt appropriate social distancing measures and limit their indoor occupancy to no more than 25 percent of their building occupancy. In addition, outdoor seating is permissible with appropriate social distancing. Appropriate social distancing requires maintaining a minimum of 6 feet between parties, only seating parties of 10 or fewer people and keeping bar counters closed to seating. This provision

extends Executive Order 20-68, Section 3 and supersedes the conflicting provisions of Executive Order 20-71, Section 2 regarding on-premises food consumption.

- C. Gyms and fitness centers closed by Executive Order 20-71 shall remain closed.
- D. The prohibition on vacation rentals in Executive Order 20-87 remains in effect for the duration of this order.
- E. The Department of Business and Professional Regulation shall utilize its authorities under Florida law to implement and enforce the provisions of this order as appropriate.

Section 4. Other Affected Business Services

Unless I direct otherwise, for the duration of this order, the following applies to other business services affected by my previous Executive Orders:

- A. In-store retail sales establishments may open storefronts if they operate at no more than 25 percent of their building occupancy and abide by the safety guidelines issued by the CDC and OSHA.
- B. Museums and libraries may open at no more than 25 percent of their building occupancy, provided, however, that (a) local public museums and local public libraries may operate only if permitted by local government, and (b) any components of museums or libraries that have interactive functions or exhibits, including child play areas, remain closed.

Section 5. Medical Procedures

Subject to the conditions outlined below, elective procedures prohibited by Executive Order 20-72 may resume when this order goes into effect. A hospital ambulatory surgical center, office surgery center, dental office, orthodontic office, endodontic office or other health care



practitioners' office in the State of Florida may perform procedures prohibited by Executive Order 20-72 only if:

- A. The facility has the capacity to immediately convert additional facility-identified surgical and intensive care beds for treatment of COVID-19 patients in a surge capacity situation;
- B. The facility has adequate personal protective equipment (PPE) to complete all medical procedures and respond to COVID-19 treatment needs, without the facility seeking any additional federal or state assistance regarding PPE supplies;
- C. The facility has not sought any additional federal, state, or local government assistance regarding PPE supplies since resuming elective procedures; and
- D. The facility has not refused to provide support to and proactively engage with skilled nursing facilities, assisted living facilities and other long-term care residential providers.

The Agency for Health Care Administration and the Department of Health shall utilize their authority under Florida law to further implement and enforce these requirements. This order supersedes the conflicting provisions of Executive Order 20-72.

Section 6. Previous Executive Orders Extended

The Executive Order 20-69 (Local Government Public Meetings) is extended for the duration of this order.

Section 7. Enforcement

This order shall be enforced under section 252.47, Florida Statutes. Violation of this order is a second-degree misdemeanor pursuant to section 252.50, Florida Statutes, and is punishable by imprisonment not to exceed 60 days, a fine not to exceed \$500, or both.

Section 8. Effective Date

This order is effective at 12:01 a.m. on May 4, 2020.



IN TESTIMONY WHEREOF, I have hereunto set my hand and caused the Great Seal of the State of Florida to be affixed, at Tallahassee, this 29th day of April, 2020.

  
\_\_\_\_\_  
RON DESANTIS, GOVERNOR

ATTEST:

  
\_\_\_\_\_  
SECRETARY OF STATE

FILED  
2020 APR 29 PM 4:52  
TALLAHASSEE, FLORIDA

## Rachel Yoho

---

**From:** Sylvia Torres  
**Sent:** Friday, May 8, 2020 1:57 PM  
**To:** Rachel Yoho  
**Cc:** Gina Peebles  
**Subject:** FW: Face Coverings

Commissioner Cornell would like this information included in the agenda item re. COVID-19 for Tuesday. Needs to be published prior to the meeting.

Sylvia

---

**From:** Ken Cornell <kcornell@alachuacounty.us>  
**Sent:** Friday, May 8, 2020 1:45 PM  
**To:** Michele Lieberman <mlieberman@alachuacounty.us>; Sylvia Torres <STorres@alachuacounty.us>  
**Cc:** Latoya T. Gainey <lgainey@alachuacounty.us>; Mark Sexton <msexton@alachuacounty.us>; kencornell@bosshardtrealty.com  
**Subject:** Face Coverings

Sylvia & Michele,

I've been reflecting on the Board's decision on May 1st, 2020 to mandate face coverings. I recognize there is currently a difference of opinion on this decision with at least one Board member and so I intend to review this information with the Board on Tuesday May 12, 2020 during our meeting.

It reaching my conclusion, the over riding goal for me was to mitigate the potential community spread of the virus while at the same time simultaneously facilitate the reopening of as many businesses as possible under the Governor's order. It is very important for Alachua County business to reopen and be given every opportunity to succeed. Having an outbreak of the virus within our Community would be detrimental to these efforts.

To this end, I spoke at length during our Board meeting about my desire to allow the Governor's 25% occupancy guidelines to stand for both Restaurant and Retail businesses. Giving these businesses the flexibility under the Governor's order to adjust their operations in my opinion is critically important to the long term success of their operations under the new normal of this virus. While Board's majority agreed with this approach for Restaurants, they did not agree with this approach for Retail and other essential businesses so we currently have a more restrictive occupancy guideline for these businesses.

Either way, it is important to recognize that Alachua County is getting back to work and as a result, more and more businesses are re-opening. Students are returning to reenter the workforce and in general there is an increase in public activity out and about. This is a good thing, as I believe we are all ready to do the necessary things to help bring back our economy while keeping the public safe and minimizing the risk of virus spread.

On April 29th, 2020, Governor DeSantis said he was in favor of people wearing face masks. His quote was, "We're recommending face masks if you're in face-to-face interactions with people particularly in the workplace if you can't adequately social distance...If you are in a face-to-face business, that to me has got to be a business practice."

With the increase in public activity, there is an increase in potential spread and therefore my desire is to attempt to mitigate this risk. Six days prior to the Governor's announcement, on April 23, 2020 the Florida Association of Counties in conjunction with IFAS had a statewide webinar for public officials with four leading experts from the University of Florida; Dr. David Nelson, Dr. John Lednický, Dr. Glenn Morris and Dr. Ira Longini. During this webinar, Dr. Lednický stated, "masking is effective to combat aerosol spread." and Dr. Morris stated, "masking could reduce the spread by 50-60%."

During at least the first two weeks of increased public activity, in my opinion, it is critically important that we take this step of mandating face coverings in order to minimize the risk of virus spread.

In addition to the above reasons, I would offer the following addition guidance that supports in my opinion and this decision.

<https://www.cdc.gov/coronavirus/2019-ncov/prevent-getting-sick/diy-cloth-face-coverings.html>

**CDC on Homemade Cloth Face Coverings**

[CDC recommends](#) wearing cloth face coverings in public settings where other social distancing measures are difficult to maintain (e.g., grocery stores and pharmacies), **especially** in areas of significant community-based transmission.

CDC also advises the use of simple cloth face coverings to slow the spread of the virus and help people who may have the virus and do not know it from transmitting it to others. Cloth face coverings fashioned from household items or made at home from common materials at low cost can be used as an additional, voluntary public health measure.

Cloth face coverings should not be placed on young children under age 2, anyone who has trouble breathing, or is unconscious, incapacitated or otherwise unable to remove the mask without assistance.

The cloth face coverings recommended are not surgical masks or N-95 respirators. Those are critical supplies that must continue to be reserved for healthcare workers and other medical first responders, as recommended by current CDC guidance.

<https://www.cdc.gov/coronavirus/2019-ncov/prevent-getting-sick/cloth-face-cover.html>

## **Recommendation Regarding the Use of Cloth Face Coverings, Especially in Areas of Significant Community-Based Transmission**

Use of Cloth Face Coverings to Help Slow the Spread of COVID-19 [Learn More](#)

CDC continues to study the spread and effects of the novel coronavirus across the United States. We now know from [recent studies](#) that a significant portion of individuals with coronavirus lack symptoms (“asymptomatic”) and that even those who eventually develop symptoms (“pre-symptomatic”) can transmit the virus to others before showing symptoms. This means that the virus can spread between people interacting in close proximity—for example, speaking, coughing, or sneezing—even if those people are not exhibiting symptoms. In light of this new evidence, CDC recommends wearing cloth face coverings in public settings where other social distancing measures are difficult to maintain (e.g., grocery stores and pharmacies) **especially** in areas of significant community-based transmission.

It is critical to emphasize that maintaining 6-foot social distancing remains important to slowing the spread of the virus. CDC is additionally advising the use of simple cloth face coverings to slow the spread of the virus and help people who may have the virus and do not know it from transmitting it to others. Cloth face coverings fashioned from household items or made at home from common materials at low cost can be used as an additional, voluntary public health measure.

The cloth face coverings recommended are not surgical masks or N-95 respirators. Those are critical supplies that must continue to be reserved for healthcare workers and other medical first responders, as recommended by current CDC guidance.

This recommendation complements and does not replace the [President’s Coronavirus Guidelines for America, 30 Days to Slow the Spread external icon](#), which remains the cornerstone of our national effort to slow the spread of the coronavirus. CDC will make additional recommendations as the evidence regarding appropriate public health measures continues to develop.

<https://www.mayoclinic.org/diseases-conditions/coronavirus/in-depth/coronavirus-mask/art-20485449>

Can face masks help prevent the spread of coronavirus disease 2019 (COVID-19)?

Yes, face masks combined with other preventive measures, such as frequent hand-washing and social distancing, help slow the spread of the disease.

So why weren't face masks recommended at the start of the pandemic?

At that time, experts didn't yet know the extent to which people with COVID-19 could spread the virus before symptoms appeared. Nor was it known that some people have COVID-19 but don't have any symptoms. Both groups can unknowingly spread the virus to others.

These discoveries led the U.S. Centers for Disease Control and Prevention (CDC) to do an about-face on face masks. The CDC updated its guidance to recommend widespread use of simple cloth face coverings to help prevent transmission of COVID-19 by people who have the virus but don't know it.

<https://www.usatoday.com/in-depth/news/2020/04/03/coronavirus-protection-how-masks-might-stop-spread-through-coughs/5086553002/>

The study published in the [Journal of the American Medical Association](#) found that under the right conditions, liquid droplets from sneezes, coughs and just exhaling can travel more than 26 feet and linger in the air for minutes.

Findings such as these may have some bearing on the [CDC's recommendation on Friday that Americans wear non-surgical face masks](#) in public — especially in places “where other social distancing measures are difficult to maintain.”

“There is no virtual wall at this 3- to 6-foot distance” says Lydia Bourouiba, the study's author, who specializes in fluid dynamics and is an associate professor at the Massachusetts Institute of Technology. These findings suggest the greatest risk is for health care workers working with infected patients, she says.

<https://www.theguardian.com/commentisfree/2020/apr/04/why-wear-a-mask-may-be-our-best-weapon-to-stop-coronavirus>

The Wölfel paper explains we must focus our efforts on stopping the spread of droplets. This is because the virus is primarily transmitted through [tiny droplets of saliva](#) ejected when we speak. You can't see them, but they are there. We also know that these droplets can go [significantly further](#) than the 6ft which is widely cited as a safe distance.

Research supported by Nobel prize-winning virologist Harold Varmus [tells us](#) that placing a layer of cloth in front of a person's face stops 99% of the droplets.

So, the science is clear. We do not know when we are sick. If we are sick, then when we speak we are projecting virus-laden droplets into the air. Wearing a simple cloth mask stops those droplets in their tracks. "I'm not going to wear a surgical mask, because clinicians need those," [said](#) Dr Harvey Fineberg, chair of the National Academy of Sciences' standing committee on emerging infectious diseases and 21st century health threats. "But I have a nice western-style bandanna I might wear. Or I have a balaclava. I have some pretty nice options." Fineberg led a committee of experts that has just released an [expert consultation](#) explaining that the virus can spread through talking, or even breathing.

I look forward to sharing this information with the full Board and discussing this further next week. Have a great weekend and stay safe,

Ken

## Rachel Yoho

---

**From:** Michele Lieberman  
**Sent:** Monday, May 11, 2020 8:29 AM  
**To:** Rachel Yoho  
**Cc:** Sylvia Torres  
**Subject:** FW: Mask scientific research summary

Rachel

The Chair would like this added to the backup along with any other commissioners that they have sent. I believe Cornell asked for his in the backup.



\* Board Certified in City, County and Local Government Law

---

**From:** hutchrk@aol.com <hutchrk@aol.com>  
**Sent:** Monday, May 11, 2020 7:46 AM  
**To:** Michele Lieberman <mlieberman@alachuacounty.us>; Sylvia Torres <STorres@alachuacounty.us>; Paul Myers <paul.myers@flhealth.gov>; BOCC (Only Commissioners) <BOCC@alachuacounty.us>  
**Cc:** Latoya T. Gainey <lgainey@alachuacounty.us>; Mark Sexton <msexton@alachuacounty.us>; Bob Swain <bswain@alachuacounty.us>  
**Subject:** Mask scientific research summary

**CAUTION:** This email originated from outside your organization. Exercise caution when opening attachments or clicking links, especially from unknown senders.

MEMO

To: Board of County Commissioners

Copy: Michele Lieberman, County Manager  
Sylvia Torres, County Attorney  
Paul Myers, County Public Health Director

Date: May 11, 2020

Subject: Recent scientific literature regarding masks

As I have communicated with numerous citizens and officials since the pandemic began to impact Alachua

County, we are a community which understands science, that values expertise, and will come together through this if we work for a common purpose based on data and facts. Therefore, I have been surprised that facial coverings have become such a divisive issue.

With a few friends, I was discussing a phrase from the writer/historian Francis Fukuyama: "Is it possible for mankind to reverse the directionality of history through the rejection or loss of the scientific method?" One of my friends, a scientist, volunteered to do a comprehensive literature search into the current science regarding masks. What follows is my social media post just after Alachua County's mask order became effective, followed by the listing of scientific literature, unedited by me and updated as of May 10<sup>th</sup>, provided by Mark Stowe who worked tirelessly on this project.

This submission is also intended to comply with public record requests regarding information that I considered when approving our Emergency Order regarding masks, and may provide additional information to our legal team.

=====

**Robert Hutchinson post to Facebook:**

May 5 at 12:56 PM ·

The Alachua County Commission enacted an emergency order requiring people to wear masks when they are interacting with others in public places. Some people – such as infants and those with mental or physical conditions that make it difficult to wear masks are exempted.

The arguments we've received from people who don't want to wear masks in public are:

- masks don't work
- you can't tell me what to do
- if you require masks, then you have to provide them, and
- why weren't they required earlier

Here's my brief response to these points:

1. Masks do reduce but not eliminate the spread of the coronavirus. They are the front line of a range of efforts that include frequent hand washing, temperature screening, abundant tests with quick and accurate results, rapid and thorough contact tracing, effective isolation, and eventually a vaccine. Of all of these, masks are the only outwardly visible signal that you are contributing to the solution. And for essential workers such as first responders, store clerks, and personal service providers who come in close proximity to dozens or hundreds of strangers each day, masks are also a sign of respect that you recognize their risk and are doing something to lower it.

2. Local governments, under the current state of emergency, have the authority to enact more protective measures than those rolled out by the State. This has been confirmed by the Governor's

office by people who have checked with them, including some who were considering legal challenges. The State of Florida has preempted its local governments from opening businesses, facilities, or activities which the State has ordered to be closed.

3. Local government agencies are not required to provide masks or other protective gear, and in many cases employers are not providing them even if they require them. This is not dissimilar to protective equipment like steel-toed shoes, safety goggles, hard hats, and other stuff that some workers are expected to wear to job sites. However, some agencies are attempting to find supplies of masks that they can provide to people so they won't be turned away, and some businesses may do the same for their customers especially as supply chains for masks become more robust and costs return to normal.

4. In the early phase of the pandemic, we didn't mandate masks for a couple of reasons. First, there was conflicting information about their effectiveness, but today there is consensus from most authorities that the benefits of widespread mask usage outweigh their costs and inconvenience. And secondly, during the six weeks of the stay-at-home phase, there were substantially fewer people out and about, and this social distancing flattened the curve of the infection rate. In this first phase of re-opening, with all retail, plus restaurants, construction sites, and many other activities back in operation, it is very likely that the epidemic will re-kindle unless we take proactive measures to reduce its person-to-person spread – and masks are one part of the strategy that each of us can do.

It deeply troubles me that store clerks are being threatened by those who are too selfish or inconsiderate to be part of the solution rather than part of the problem. And those who say they would wear a mask only if you suggest we do, but will refuse if you tell us we have to, are engaging in juvenile temper tantrums. We are all frustrated, but taking it out on store clerks is simply indecent.

And then there's folks who have said they would comply if the President or Governor say we have to, but not if local officials do. I wish those at the top were making it easier by leading, but from my vantage point, local governments are doing the best that we can with the information and resources we have, and have shown creativity, flexibility, and transparency to the best of our abilities.

Thank you for your efforts, large and small, to work together towards a full and safe recovery for our community.

Robert Hutchinson

Alachua County Commissioner

=====

**E-mail received from Mark Stowe to Robert Hutchinson, May 11, 2020:**

The following are all the professional literature articles I found after doing a search in



scholar.google.com (which fairly exhaustively covers journal publications from around the world, as well as publications by governments and scientific organizations). I searched for the keywords facemask and covid19 and sorted by date and used only hits from April and May this year, including many preprints. I have not used papers concerning masks in the hospital setting - just general public use of any kind of mask. I found that clearly pro-mask hits outnumbered equivocal- to- tepid- support hits almost three to one, (48 positive 16 neutral 3 negative)

All links lead to the full article (or look for “download pdf” or similar - all journals are making Covid19 related publications open access). Excerpts reflect the article’s viewpoint, and for some articles indicate that they describe simple ways to make masks (including some novel designs). Some articles point out that all airlines (or at least all US airlines) are requiring the use of facemasks.

## **Unambiguously promask hits**

### **Published articles and reviews and preprints that argue for masks**

To mask or not to mask: Modeling the potential for face mask use by the general public to curtail the COVID-19 pandemic

Infectious Disease Modelling Volume 5, 2020, Pages 293-308  
<https://www.sciencedirect.com/science/article/pii/S2468042720300117>

.....broad adoption of even relatively ineffective face masks may meaningfully reduce community transmission of COVID-19 and decrease peak hospitalizations and deaths

Community Universal Face Mask Use during the COVID 19 pandemic—from households to travelers and public spaces

J Travel Med. 2020 Apr 18 <https://www.ncbi.nlm.nih.gov/pmc/articles/PMC7188149/>

... that mask use in the community has no benefit, and should only be used by sick patients (also referred to as “source control” (3)). Such messaging may be driven more by concerns about critical shortages of personal protective equipment for health workers than by scientific evidence. In fact there are more large randomized, controlled clinical trials (RCTs) of face mask use in the community than there are of use by sick people or “source control”.

Efficacy of face mask in preventing respiratory virus transmission: a systematic review and meta-analysis

(Preprint) <https://www.medrxiv.org/content/10.1101/2020.04.03.20051649v2.abstract>

..... A total of 21 studies met our inclusion criteria. Meta-analyses suggest that mask use provided a significant protective effect (OR = 0.35 and 95% CI = 0.24-0.51).

Applying principles of behaviour change to reduce SARS-CoV-2 transmission

Nat Hum Behav (2020). <https://www.nature.com/articles/s41562-020-0887-9>

.....we urgently need effective interventions to increase adherence to behaviours that individuals in communities can enact to protect themselves and others: use of tissues to catch expelled droplets from coughs or sneezes, use of face masks as appropriate, .....

Universal Masking is Urgent in the COVID-19 Pandemic:SEIR and Agent Based Models, Empirical Validation, Policy Recommendations

physics.soc-ph 22 Apr 2020 <https://arxiv.org/pdf/2004.13553.pdf>

.....Taken in tandem, our theoretical models and empirical results argue for urgent implementation of universal

masking in regions that have not yet adopted it as policy

Mathematical assessment of the impact of non-pharmaceutical interventions on curtailing the 2019 novel Coronavirus

Mathematical Biosciences Volume 325, July 2020, 108364  
<https://www.sciencedirect.com/science/article/pii/S0025556420300560>

.....High use of face-masks in public could lead to COVID-19 elimination.

The Case for Universal Cloth Mask Adoption and Policies to Increase Supply of Medical Masks for Health Workers

(Preprint from Yale) [https://papers.ssrn.com/sol3/papers.cfm?abstract\\_id=3567438](https://papers.ssrn.com/sol3/papers.cfm?abstract_id=3567438)

.....We recommend the immediate universal adoption of cloth facemasks, including homemade

Face masks for the public during the covid-19 crisis

BMJ 2020;369:m1435  
[https://www.zora.uzh.ch/id/eprint/187180/1/Greenhalgh\\_Schmid\\_FaceMasks\\_bmj\\_2020\\_Neo\\_USZ.pdf](https://www.zora.uzh.ch/id/eprint/187180/1/Greenhalgh_Schmid_FaceMasks_bmj_2020_Neo_USZ.pdf)

..... in the face of a pandemic the search for perfect evidence may be the enemy of good policy. As with parachutes for jumping out of aeroplanes,<sup>38</sup> it is time to act without waiting for randomised

controlled trial evidence.<sup>39</sup> A recently posted preprint of a systematic review came to the same conclusion.<sup>40</sup> Masks are simple, cheap, and potentially effective.

Airborne transmission of SARS-CoV-2: The world should face the reality

Environment International Volume 139, June 2020, 105730

<https://www.sciencedirect.com/science/article/pii/S016041202031254X>

..... in particular masks and respirators should be recommended, to be used in public places where density of people is high

Masks and thermometers: Paramount measures to stop the rapid spread of SARS-CoV-2 in the United States

Genes & Diseases 25 April 2020

<https://www.sciencedirect.com/science/article/pii/S2352304220300635>

.....We believe that masks and thermometers are key measures

A Rapid Systematic Review Of The Efficacy Of Face Masks And Respirators Against Coronaviruses And Other Respiratory Transmissible Viruses For The Community, Healthcare Workers And Sick Patients

International Journal of Nursing Studies 30 April 2020, 103629

<https://www.sciencedirect.com/science/article/pii/S0020748920301139>

.....The study suggests that community mask use by well people could be beneficial, particularly for COVID-19,

The Practice of Wearing Surgical Masks during the COVID-19 Pandemic

EID Journal Volume 26 [https://wwwnc.cdc.gov/eid/article/26/8/20-1498\\_article](https://wwwnc.cdc.gov/eid/article/26/8/20-1498_article)

.....the wearing of masks by healthy persons may prevent potential asymptomatic or presymptomatic transmission (3). This marginal reduction in transmission may produce substantial results, particularly when implemented early.

Ontarians Need to Rapidly Increase their Personal Protection and Testing to Mitigate the COVID-19 Spread in the Province

(Preprint) [https://papers.ssrn.com/sol3/papers.cfm?abstract\\_id=3569731](https://papers.ssrn.com/sol3/papers.cfm?abstract_id=3569731)

.....We show that the adoption of personal protective equipment and rapid testing may be key to achieve control of COVID-19 in Ontario.

### Face Masks Against COVID-19: An Evidence Review

(Preprint) [https://www.preprints.org/manuscript/202004.0203/v1?fbclid=IwAR37tSbzMXeOSV-hm76KLi\\_dgSljxc8IOAHJ1HyYb4TrWGXhOHMsQMvgDQk](https://www.preprints.org/manuscript/202004.0203/v1?fbclid=IwAR37tSbzMXeOSV-hm76KLi_dgSljxc8IOAHJ1HyYb4TrWGXhOHMsQMvgDQk)

.....We recommend that public officials and governments strongly encourage the use of widespread face masks in public, including the use of appropriate regulation.

### COVID-19 and Face Masks – To Use or Not to Use!

Indian J Comm Health. 2020;32(2-Special Issue):240-243.

[https://www.researchgate.net/profile/Devraj\\_Ramakrishnan/publication/340792638\\_COVID-19\\_and\\_Face\\_Masks\\_-\\_To\\_Use\\_or\\_Not\\_to\\_Use/links/5e9dd709299bf13079ad7b1d/COVID-19-and-Face-Masks-To-Use-or-Not-to-Use.pdf](https://www.researchgate.net/profile/Devraj_Ramakrishnan/publication/340792638_COVID-19_and_Face_Masks_-_To_Use_or_Not_to_Use/links/5e9dd709299bf13079ad7b1d/COVID-19-and-Face-Masks-To-Use-or-Not-to-Use.pdf)

Along with mask use, practicing all other preventive measures such as handwashing, cough etiquette, social distancing, quarantine and isolation are of utmost importance,

### Covid-19 Preventative Measures Bandanas As Cloth Face Coverings

(UF IFAS Extension FSHN20-32) <https://journals.flvc.org/edis/article/view/121781/120582>

.....Cloth face coverings can be an effective way of preventing spread of infectious diseases.

### Masks and Coronavirus Disease 2019 (COVID-19)

(Journal of the American Medical Association patient advice)  
<https://jamanetwork.com/journals/jama/fullarticle/2764955>

.....Primary benefits of wearing a mask include limiting the spread of the virus from someone who knows or does not know they have an infection to others.

### Flow analyses to validate SARS-CoV-2 protective masks

(Preprint of German fluid mechanics engineering study with lots of photos) [https://www.unibw.de/lrt7-en/report\\_mask-investigation\\_unibw\\_lrt7\\_06\\_04\\_2020.pdf](https://www.unibw.de/lrt7-en/report_mask-investigation_unibw_lrt7_06_04_2020.pdf)

.....Finally, the last part of the video shows how a particle-filtering protective mask can be manufactured very easily, quickly and inexpensively and how it must be worn in order to provide reliable protection. The material costs for such a mask are about 50 cents and the production takes about 5 minutes with some practice.

Aerosol Particles Laden with COVID-19 Travel Over 30m Distance

(Preprint) <https://www.preprints.org/manuscript/202004.0546/v1>

.....For example, a person in a public place (e.g. supermarket or car park) can accumulate in the respiratory system up to 200 virus copies in 2 min time by breathing in virus laden aerosols. Wearing face mask considerably reduces the deposited load down to 2 virus copies per 2 min.

The Psychology of Wearing Face Masks in Times of the COVID-19 Pandemic

(Preprint) [https://papers.ssrn.com/sol3/papers.cfm?abstract\\_id=3584834](https://papers.ssrn.com/sol3/papers.cfm?abstract_id=3584834)

.....The more people use masks, the less strange it feels for the people to wear masks and so the higher the acceptance for using them in a sustainable way. This assists to efficiently and effectively reduce the risk of infecting others.

Modelling SARS-COV2 Spread in London: Approaches to Lift the Lockdown

(Preprint) <https://www.preprints.org/manuscript/202005.0055>

.... the best strategy seems to be a combination of weekly universal testing, contact tracing and use of facemasks, with concurrent lockdown. This approach could potentially reduce deaths by 76% compared with continued lockdown alone.

The use of facemasks by the general population to prevent transmission of Covid 19 infection: A systematic review.

(Preprint) <https://www.medrxiv.org/content/10.1101/2020.05.01.20087064v1>

.....Conclusion Theoretical, experimental, and clinical evidence suggested that usage of face masks in a general population offered significant benefit in preventing the spread of respiratory viruses especially in the pandemic situation

A reality check on the use of face masks during the COVID-19 outbreak in

Hong Kong

EClinicalMedicine 000 (2020) 100356 [https://www.thelancet.com/pdfs/journals/eclinm/PIIS2589-5370\(20\)30100-0.pdf](https://www.thelancet.com/pdfs/journals/eclinm/PIIS2589-5370(20)30100-0.pdf)

.....mass masking in the community is one of the key measures that controls transmission during the outbreak in Hong Kong and China.....

Over view for the truth of COVID -19 pandemic: A guide for the Pathologists, Health care workers and community'

(Preprint) <https://pjms.org.pk/index.php/pjms/article/download/2519/542>

Conclusion: Hand washing, using face masks, adopting respiratory etiquette, and cleaning surface and objects, social distancing and travel measures can protect us from the COVID19.

The Covid-19 Crisis and the need for suitable face masks for the general population

(Preprint) [https://www.researchgate.net/publication/341057183\\_The\\_Covid-19\\_Crisis\\_and\\_the\\_need\\_for\\_suitable\\_face\\_masks\\_for\\_the\\_general\\_population](https://www.researchgate.net/publication/341057183_The_Covid-19_Crisis_and_the_need_for_suitable_face_masks_for_the_general_population)

.....The question is not should the general public have mask protection but what degree of mask protection is needed?

A Simple Homemade Cloth Mask for Mass People in Covid-19: Salt-Starching Treatment on Fabric for Better Bioaerosol Filtration Efficiency

(Preprint)

[https://www.researchgate.net/profile/M\\_Mehedi\\_Rocky/publication/341105738\\_A\\_Simple\\_Homemade\\_Cloth\\_Mask\\_for\\_Mass\\_People\\_in\\_Covid-19\\_Salt-Starching\\_Treatment\\_on\\_Fabric\\_for\\_Better\\_Bioaerosol\\_Filtration\\_Efficiency/links/5eadc09392851cb2676f9323/A-Simple-Homemade-Cloth-Mask-for-Mass-People-in-Covid-19-Salt-Starching-Treatment-on-Fabric-for-Better-Bioaerosol-Filtration-Efficiency.pdf](https://www.researchgate.net/profile/M_Mehedi_Rocky/publication/341105738_A_Simple_Homemade_Cloth_Mask_for_Mass_People_in_Covid-19_Salt-Starching_Treatment_on_Fabric_for_Better_Bioaerosol_Filtration_Efficiency/links/5eadc09392851cb2676f9323/A-Simple-Homemade-Cloth-Mask-for-Mass-People-in-Covid-19-Salt-Starching-Treatment-on-Fabric-for-Better-Bioaerosol-Filtration-Efficiency.pdf)

..... facial mask, use of which is equally vital, if not more, than social-distancing, sheltering-in-place, and other vast measures widely used across the world to slow the spread of COVID-19. A simple way to make a mask of improved filtration efficiency at home is presented using cotton or linen woven fabric available in wearable cloth or household napkin. Filtration efficacy was improved by salt-starch treatment. Starch increases the efficiency of pathogenic droplet absorption by the fabric, whereas salt improves the virus deactivation system.

## Why we should wear face masks to tackle COVID-19

(Preprint)

[https://www.researchgate.net/profile/Anthony\\_Webster3/publication/340869960\\_Why\\_we\\_should\\_we\\_ar\\_face\\_masks\\_to\\_tackle\\_COVID-19/links/5ea2d7eb92851c87d1b10ce7/Why-we-should-wear-face-masks-to-tackle-COVID-19.pdf](https://www.researchgate.net/profile/Anthony_Webster3/publication/340869960_Why_we_should_we_ar_face_masks_to_tackle_COVID-19/links/5ea2d7eb92851c87d1b10ce7/Why-we-should-wear-face-masks-to-tackle-COVID-19.pdf)

.....Despite the uncertainties, the likely cost of basic masks seems very low compared to their possible benefit in terms of lives saved, especially if they are used when we are leaving “lockdown”.

Evidence-based, cost-effective interventions to suppress the COVID19 pandemic: a rapid systematic review

(Preprint) <https://www.medrxiv.org/content/medrxiv/early/2020/04/24/2020.04.20.20054726.full.pdf>

social distancing is effective but costly, especially when adopted late and (2) adopting as early as possible a combination of interventions that includes hand washing, face masks, swift contact tracing and case isolation, and protective equipment for healthcare workers is likely to be the most cost-effective strategy.

## Wearing Face Masks — the Simple and Effective Way to Block the Infection Source of COVID-19

CCDCWeekly <http://weekly.chinacdc.cn/en/article/doi/10.46234/ccdcw2020.069>

.....wear face masks” is a simple, feasible, and low-cost method of blocking the infection source and can result in the epidemic being effectively controlled as evidenced in China and the Republic of Korea.

## Evidence to Support Wearing Masks Is Helpful During the COVID-19 Pandemic

(Preprint) <https://osf.io/e58mr/download?format=pdf>

.....Although wearing masks should never replace or substitute other effective measures recommended by public health agencies and experts, the evidence in Asian countries suggests that it might additionally enhance the efficacy of preventive measures in today’s detrimental COVID-19 outbreak.

Transmission Mode and Infection Mode decide Evacuated Quarantine

(Preprint)

[https://www.researchgate.net/profile/Li-Yuan-Liu/publication/340941325\\_Transmission\\_Mode\\_and\\_Infection\\_Mode\\_decide\\_Evacuated\\_Quarantine/links/5ea6b99c45851553fab2e352/Transmission-Mode-and-Infection-Mode-decide-Evacuated-Quarantine.pdf](https://www.researchgate.net/profile/Li-Yuan-Liu/publication/340941325_Transmission_Mode_and_Infection_Mode_decide_Evacuated_Quarantine/links/5ea6b99c45851553fab2e352/Transmission-Mode-and-Infection-Mode-decide-Evacuated-Quarantine.pdf)

.....As a sum, we suggest selective evacuation and mandatory wearing masks:

A Comfortably Vented, Ingeniously Designed (COVID) Fabric Helmet for Curbing Infection Spread in Community Settings

(Preprint) [https://papers.ssrn.com/sol3/papers.cfm?abstract\\_id=3577540](https://papers.ssrn.com/sol3/papers.cfm?abstract_id=3577540)

.....the need of protective gear such as facemasks assumes utmost importance, for the common populace,

Face mask use in the general population and optimal resource allocation during the COVID-19 pandemic

(Preprint) <https://www.medrxiv.org/content/medrxiv/early/2020/04/07/2020.04.04.20052696.full.pdf>

In summary, face mask use, particularly for a pathogen with relatively common asymptomatic carriage, can effectively provide some mitigation of transmission,

Public use of face masks to control the coronavirus (SARS-Cov-2) pandemic: a review of theory and evidence

(Preprint) [https://www.preprints.org/manuscript/202004.0021/download/final\\_file](https://www.preprints.org/manuscript/202004.0021/download/final_file)

Homemade cloth face masks to fight the COVID19 pandemic; a call for mass public masking with homemade cloth masks

(Preprint) <https://osf.io/preprints/socarxiv/grbzj/download>

**Professional journal editorials that argue for masks  
(I found the last one particularly poignant and compelling)**



## The Time for Universal Masking of the Public for Coronavirus Disease 2019 Is Now

Open Forum Infectious Diseases, Volume 7, Issue 4, April 2020

<https://academic.oup.com/ofid/article/7/4/ofaa131/5820544>

In conclusion, we strongly endorse universal public masking in the United States for crowded indoor or public spaces, including supermarkets, public gatherings, and in close workplaces. This recommendation does not replace our population-level, public health approaches, including social distancing in the short term, but it does serve as an adjunct, with the hope that we will be able to relax such measures as transmission slows

## Rationale for universal face masks in public against COVID-19

Respirology (2020) 13834 <https://onlinelibrary.wiley.com/doi/pdf/10.1111/resp.13834>

....Weighing up all these considerations, there is modest evidence to support widespread community use of universal masking, which includes cloth masks to help reduce transmission of SARS-CoV-2.

## Public Masking: An Urgent Need to Revise Global Policies to Protect against Novel Coronavirus Disease (COVID-19)

Am. J. Trop. Med. Hyg., 00(0), 2020, pp. 1–2

[https://web.archive.org/web/20200509164221/http://pr.tums.ac.ir/uploads/1/2020/Apr/23/Keshtkar-Mark-Holakouie\\_Editorial\\_Pulic%20Masking%20\(1\).pdf](https://web.archive.org/web/20200509164221/http://pr.tums.ac.ir/uploads/1/2020/Apr/23/Keshtkar-Mark-Holakouie_Editorial_Pulic%20Masking%20(1).pdf) (webarchive copy of a preprint hosted in Iran which has been devastated by the virus and where the server is down)

## Universal use of face masks for success against COVID-19: evidence and implications for prevention policies

Eur Respir J 2020; in press <https://erj.ersjournals.com/content/erj/early/2020/04/27/13993003.01260-2020.full.pdf>

....However, in blanket testing of an isolated village of approximately 3,000 people in northern Italy, 50%-75% of people with positive pharyngeal molecular tests were totally asymptomatic [1]. This finding was echoed by a more recent daily surveillance report from China, where all people arriving from overseas were rigorously tested [2]: among 166 persons with newly identified infections, 78% were asymptomatic. .... With the large number of asymptomatic patients unaware of their own infection [1,2], the comparable viral load in their upper respiratory tract [3], droplet and aerosol dispersion even during talking and breathing [6], and prolonged viral viability outside our body [7], we strongly advocate universal use of face mask as a means of source control in public places during the COVID-19 pandemic. Extreme forms of social distancing is not sustainable, and complete lockdown of cities or even whole countries is extremely devastating to the economy. Universal masking in public complements social distancing and hand hygiene in containing or slowing down the otherwise exponential growth of the pandemic. Universal masking protects against cross transmission through

unavoidable person-to-person contact during the lockdown and reduces the risk for resurgence during relaxation of social distancing measures on reopening.

#### Use of facemasks to limit COVID-19 transmission

Epidemiol. Serv. Saúde 29 (2) 22 Apr 2020

<https://www.scielosp.org/article/ress/2020.v29n2/e2020023/en/>

.....Community transmission could be reduced if everyone, including asymptomatic and contagious people, used facemasks.

#### Wearing face masks in the community during the COVID-19 pandemic: altruism and solidarity

[https://www.thelancet.com/pdfs/journals/lancet/PIIS0140-6736\(20\)30918-1.pdf](https://www.thelancet.com/pdfs/journals/lancet/PIIS0140-6736(20)30918-1.pdf)

.....Mass masking for source control is in our view a useful and low-cost adjunct to social distancing and hand hygiene during the COVID-19 pandemic.

#### Covid-19: should the public wear face masks?

BMJ 2920;369:m1442 <http://press.psprings.co.uk/bmj/april/facemasksedit.pdf>

.....As we prepare to enter a “new normal,” wearing a mask in public may become the face

of our unified action in the fight against this common threat and reinforce the importance of social distancing measures

#### The COVID-19 outbreak: The issue of face masks

Infection Control & Hospital Epidemiology <https://www.cambridge.org/core/journals/infection-control-and-hospital-epidemiology/article/covid19-outbreak-the-issue-of-face-masks/76DD0766082548F9BEF74FF85B152324/core-reader>

..... 3 measures should be undertaken: (1) improve the supply of masks; (2) promote public awareness about how to deal with discarded masks; (3) carry out innovation to improve masks.

#### Cloth face covers – a sustainable measure to mitigate COVID-19

(Preprint) [https://www.theunion.org/news-centre/news/body/IJTL-D-June-0220\\_Letter\\_Jindal-FINAL.pdf](https://www.theunion.org/news-centre/news/body/IJTL-D-June-0220_Letter_Jindal-FINAL.pdf)

.....the use of cloth masks or any alternate cover by the general public seems a practical health intervention.

<http://apiindia.org/wp-content/uploads/pdf/corona-virus/review-article-on-mask.pdf>

\*\*\*<https://journals.sagepub.com/doi/full/10.1177/0890117120922037>

### **Govt blogs etc that are pro-mask**

Uso De Barbijos (Mascarillas) En La Pandemia Por Covid-19

<http://cimenuuevo.blogs.fcq.unc.edu.ar/wp-content/uploads/sites/15/2020/04/Informe-CIME-uso-de-barbijos-COVID-19-22-04-20.pdf>

Why NZ should consider adopting “mass masking” as an additional step to speed elimination of the Covid-19 pandemic <https://sciblogs.co.nz/public-health-expert/2020/04/22/why-nz-should-consider-adopting-mass-masking-as-an-additional-step-to-speed-elimination-of-the-covid-19-pandemic/>

Department of Health recommends the use of masks during COVID-19

<https://www.foodfocus.co.za/home/whats-hot/Corona-Virus/Department-of-Health-recommends-the-use-of-masks-during-COVID19>

### **Articles that take a more neutral stance**

If right kind and used correctly yes

<https://pubs.acs.org/doi/full/10.1021/acsnano.0c03252>

Tepid yes but still needs study

<https://onlinelibrary.wiley.com/doi/epdf/10.5694/mja2.50602>

Public use of face masks to control the coronavirus (SARS-Cov-2) pandemic: a review of theory and evidence

(Preprint) [https://www.preprints.org/manuscript/202004.0021/download/final\\_file](https://www.preprints.org/manuscript/202004.0021/download/final_file)

Presents arguments for and against seems to learn towards for

<https://ipatec.conicet.gov.ar/wp-content/uploads/sites/72/2020/04/Documento-Tecnico-IPATEC-V4.pdf>

[http://cienciorama.unam.mx/a/pdf/634\\_cienciorama.pdf](http://cienciorama.unam.mx/a/pdf/634_cienciorama.pdf)

Role of Mask/Respirator Protection Against SARS-CoV-2

Anesth Analg. 2020 Apr 20 : <https://www.ncbi.nlm.nih.gov/pmc/articles/PMC7173698/>

Effectiveness of manufactured surgical masks, respirators, and home-made masks in prevention of respiratory infection due to airborne microorganisms

The Southwest Respiratory and Critical Care Chronicles 2020;8(34):11–26

<https://pulmonarychronicles.com/index.php/pulmonarychronicles/article/download/675/1525>

Maybe yes maybe no needs more study

<https://www.nap.edu/read/25776/chapter/1>

<https://www.medrxiv.org/content/medrxiv/early/2020/04/14/2020.04.09.20058859.full.pdf>

The flow physics of COVID-19

J. Fluid Mech. (2020), vol. 894, F2 <https://www.cambridge.org/core/services/aop-cambridge-core/content/view/476E32549012B3620D2452F30F2567F1/S0022112020003304a.pdf/div-class-title-the-flow-physics-of-covid-19-div.pdf>

## **Pros and Cons needs more study takes no stand**

Masking During the COVID-19 Pandemic

[https://ncceh.ca/sites/default/files/Masking%20during%20the%20pandemic NCCEH%20April%202020.pdf](https://ncceh.ca/sites/default/files/Masking%20during%20the%20pandemic%20NCCEH%20April%202020.pdf)

Concerns around public health recommendations on face mask use among individuals who are not medically diagnosed with COVID-19 supported by a systematic review search for evidence.

(Preprint) <https://europepmc.org/article/ppr/ppr150003>

RE: Face mask and COVID-19

(Letter to editor) <https://www.cmaj.ca/content/re-face-mask-and-covid-19>

## **Couldn't find evidence of benefit**

Impact of non-pharmaceutical interventions against COVID-19 in Europe: a quasi-experimental study

(Preprint) medRxiv 2020.05.01.20088260

<https://www.medrxiv.org/content/10.1101/2020.05.01.20088260v1.full.pdf>

Face masks to prevent community transmission of viral respiratory infections: A rapid evidence review using Bayesian analysis

(Preprint) <https://www.qeios.com/read/1SC5L4>

## **Mixed leaning towards negative**

Face masks for the public during Covid-19: an appeal for caution in policy

(Preprint) <https://osf.io/preprints/socarxiv/uyzxe/>

Facemasks and the Covid 19 pandemic: What advice should health professionals be giving the general public about the wearing of facemasks?

(Editorial) *Nursing & Health Sciences*. <https://onlinelibrary.wiley.com/doi/abs/10.1111/nhs.12724>

Q. Are cloth masks safe and effective for preventing the spread of COVID-19?

(Answer to online question) <http://mdanderson.libanswers.com/faq/293442>

# # #

I should start by emphasizing that I'm not against masks. However...

The World Health Organization advises healthy people not to wear masks. The Centers for Disease Control recommends the wearing of masks by asymptomatic people, but stops short of advising a mandatory policy. Public Health England (their version of the CDC,) advises against masks for healthy people. There are reasons for the reluctance of leading public health agencies to call for mandatory mask rules.

The actual evidence regarding the idea that masks are effective in preventing the spread of Covid-19 is scant and contradictory. Those studies that have been done test only the physical ability of different kinds of mask materials to block the movement of the Covid-19 virus, under laboratory conditions. We quickly learned that masks available to the public are ineffective at blocking the Covid-19 virus when inhaling, and so don't protect the wearer, but might retard the movement of the virus when exhaling or coughing, and so might protect other people from the wearer. And so, people began to support the idea that even though we don't yet have a scientific basis for policy, wearing masks can't hurt, and might help, so why not require them? And then, of course, the subject quickly devolved into a ridiculous political spat, with those who don't care about their fellow human beings and don't understand science versus those who don't care about human liberty.

The problem is that no study has yet been done regarding how human beings actually use masks outside laboratories. In the real world, masks may, in fact, conflict with more important protective behaviors, increase the risk of infection for wearers, and have secondary negative consequences for public health. The following article provides a brief summary, from the perspective of frontline doctors, of the potential downsides to wearing masks (a topic which seems to have been almost completely ignored in the general discussion to this point): <https://www.bmj.com/content/369/bmj.m1435/rr-40>

We do have strong consensus that the most important things we can do to protect ourselves and prevent the spread of the virus are the big three: distance ourselves from others in public; sanitize hands frequently; and above all, avoid touching our own faces. These are all low cost, high benefit strategies. However, if masks aren't properly handled, they can undercut these objectives, and remarkably few people seem to be handling them properly. People frequently and unconsciously tug, pull up, and adjust their masks, which are uncomfortable, particularly for those with facial hair, sensitive skin, or glasses. Masks tend to direct breath into the eyes, which fogs glasses and increases discomfort. All this results in a lot more face touching, the worst thing we can do. And of course, masks, which are magnets for the virus from both inside and outside, have to be precisely placed onto and taken off the face, handled very carefully, and laundered after each use (not after each day of shopping at several stores.) Face masks tend to give wearers a false sense of security, leading to relaxed adherence to proper social distancing (which, again, is more important than wearing masks.) These problems exist for people who want to wear masks; it's not hard to imagine how great the problems will be for those resentful of being forced to.

None of this even begins to address the long-term psychological and sociological consequences of mandatory universal face mask wearing, which, once initiated, won't be easy to reverse. Why shouldn't mask logic apply regarding the flu, which kills between 300,000 and 650,000 people a year? That upper estimate is twice the number of Covid-19 deaths to date (not that they're in competition.)

For these reasons, while I encourage those who want to wear masks to do so, I think it's premature for government to mandate it. There are too many individual health variables involved to understand the

potential consequences. As with everything involving the pandemic, my opinion is subject to change as we learn more.





## Coronavirus Disease 2019 (COVID-19)

# Cloth Face Coverings: Questions and Answers

This document is intended to address frequently asked questions about cloth face coverings.

### Why do you need to wear cloth face coverings? –

In light of new data about [how COVID-19 spreads](#), along with evidence of widespread COVID-19 illness in communities across the country, CDC recommends that people wear a [cloth face covering](#) to cover their nose and mouth in the community setting. This is to protect people around you if you are infected but do not have symptoms.

### When do you need to wear a cloth face covering? –

A cloth face covering should be worn whenever people are in a community setting, especially in situations where you may be near people. These settings include grocery stores and pharmacies. These face coverings are not a substitute for social distancing. Cloth face coverings are especially important to wear in public in areas of widespread COVID-19 illness.

### Do I still need to stay at least 6 feet away from people if wearing a cloth face covering? –

Yes. Wearing cloth face coverings is an additional public health measure people should take to reduce the spread of COVID-19. CDC still recommends that you stay at least 6 feet away from other people (social distancing), frequent hand cleaning and other everyday preventive actions. A cloth face covering is not intended to protect the wearer, but it may prevent the spread of virus from the wearer to others. This would be especially important if someone is infected but does not have symptoms. View CDC's guidance on [how to protect yourself](#).

### What type of cloth face covering should be worn? –

Cloth face coverings can be made from household items or made at home from common materials at low cost.

## Who should not wear cloth face coverings? —

Cloth face coverings should not be placed on young children younger than 2 years of age, anyone who has trouble breathing, or is unconscious, incapacitated or otherwise unable to remove the cover without assistance.

## Why is CDC recommending cloth face coverings instead of medical grade facemasks? —

Surgical masks and N95 respirators are in short supply and should be reserved for healthcare workers or other medical first responders, as recommended by CDC guidance.



[View Larger](#)

[How to Safely Wear and Take Off a Cloth Face Covering](#) 

Page last reviewed: April 4, 2020

# Use of Cloth Face Coverings to Help Slow the Spread of COVID-19

## How to Wear Cloth Face Coverings

Cloth face coverings should—

- fit snugly but comfortably against the side of the face
- be secured with ties or ear loops
- include multiple layers of fabric
- allow for breathing without restriction
- be able to be laundered and machine dried without damage or change to shape

## CDC on Homemade Cloth Face Coverings

CDC recommends wearing cloth face coverings in public settings where other social distancing measures are difficult to maintain (e.g., grocery stores and pharmacies), **especially** in areas of significant community-based transmission.

CDC also advises the use of simple cloth face coverings to slow the spread of the virus and help people who may have the virus and do not know it from transmitting it to others. Cloth face coverings fashioned from household items or made at home from common materials at low cost can be used as an additional, voluntary public health measure.

Cloth face coverings should not be placed on young children under age 2, anyone who has trouble breathing, or is unconscious, incapacitated or otherwise unable to remove the cloth face covering without assistance.

The cloth face coverings recommended are not surgical masks or N-95 respirators. Those are critical supplies that must continue to be reserved for healthcare workers and other medical first responders, as recommended by current CDC guidance.

## Should cloth face coverings be washed or otherwise cleaned regularly? How regularly?

Yes. They should be routinely washed depending on the frequency of use.

## How does one safely sterilize/clean a cloth face covering?

A washing machine should suffice in properly washing a cloth face covering.

## How does one safely remove a used cloth face covering?

Individuals should be careful not to touch their eyes, nose, and mouth when removing their cloth face covering and wash hands immediately after removing.

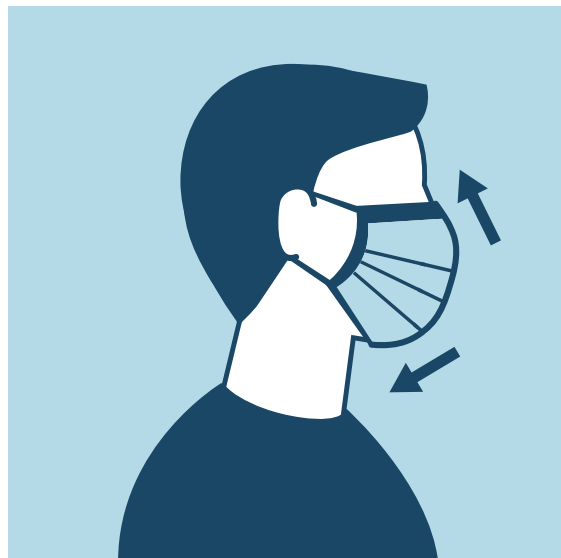

# Sewn Cloth Face Covering

## Materials

- Two 10"x6" rectangles of cotton fabric
- Two 6" pieces of elastic (or rubber bands, string, cloth strips, or hair ties)
- Needle and thread (or bobby pin)
- Scissors
- Sewing machine

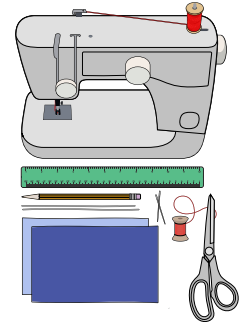

## Tutorial

1. Cut out two 10-by-6-inch rectangles of cotton fabric. Use tightly woven cotton, such as quilting fabric or cotton sheets. T-shirt fabric will work in a pinch. Stack the two rectangles; you will sew the cloth face covering as if it was a single piece of fabric.

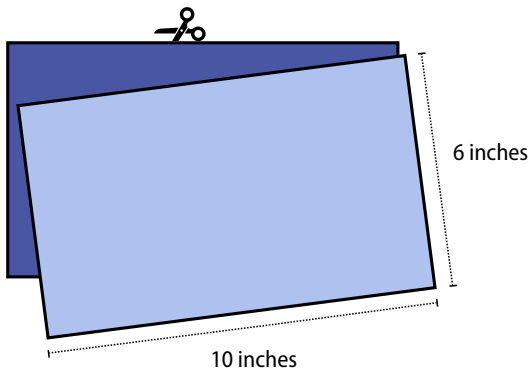

2. Fold over the long sides 1/4 inch and hem. Then fold the double layer of fabric over 1/2 inch along the short sides and stitch down.

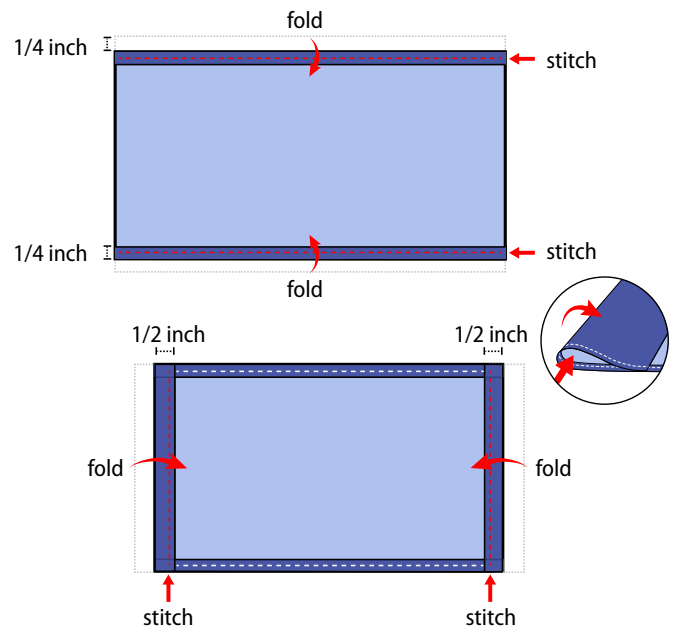

3. Run a 6-inch length of 1/8-inch wide elastic through the wider hem on each side of the cloth face covering. These will be the ear loops. Use a large needle or a bobby pin to thread it through. Tie the ends tight. Don't have elastic? Use hair ties or elastic head bands. If you only have string, you can make the ties longer and tie the cloth face covering behind your head.

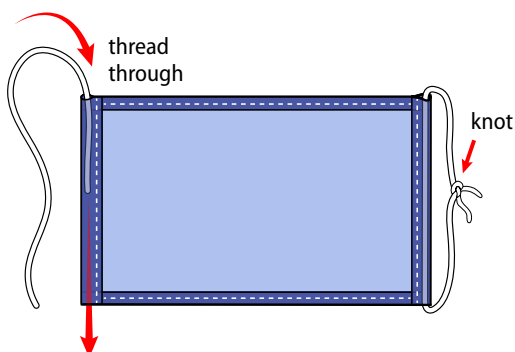

4. Gently pull on the elastic so that the knots are tucked inside the hem. Gather the sides of the cloth face covering on the elastic and adjust so the mask fits your face. Then securely stitch the elastic in place to keep it from slipping.

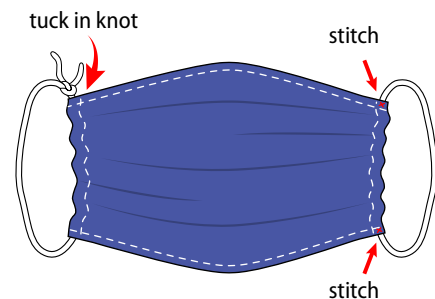

## Quick Cut T-shirt Cloth Face Covering (no sew method)

### Materials

- T-shirt
- Scissors

### Tutorial

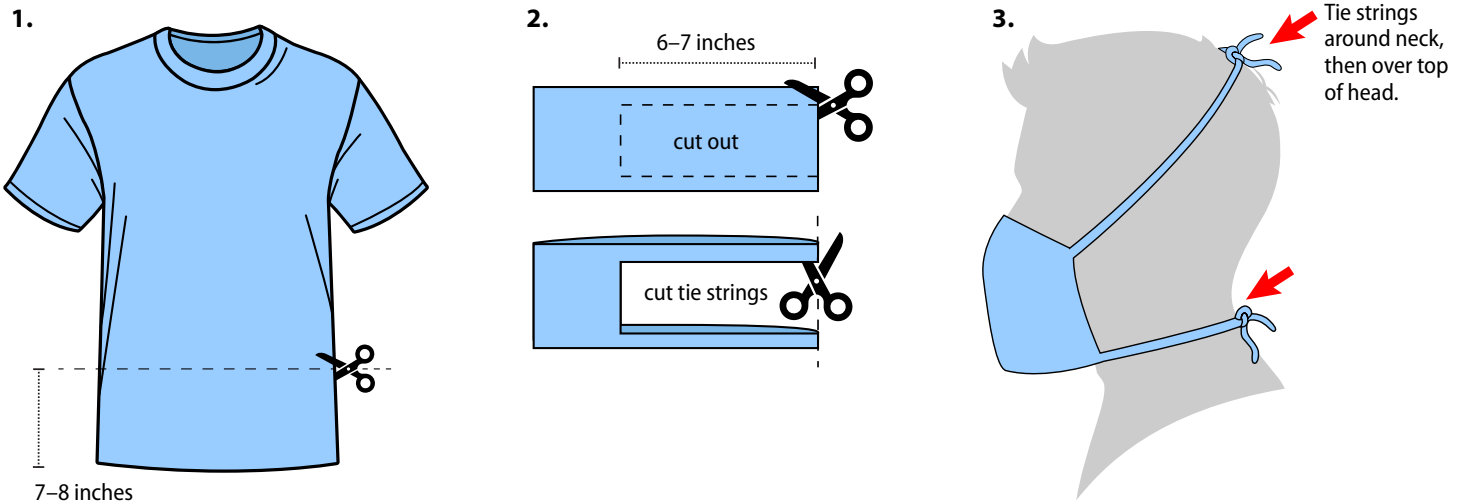

## Bandana Cloth Face Covering (no sew method)

### Materials

- Bandana (or square cotton cloth approximately 20"x20")
- Rubber bands (or hair ties)
- Scissors (if you are cutting your own cloth)

### Tutorial

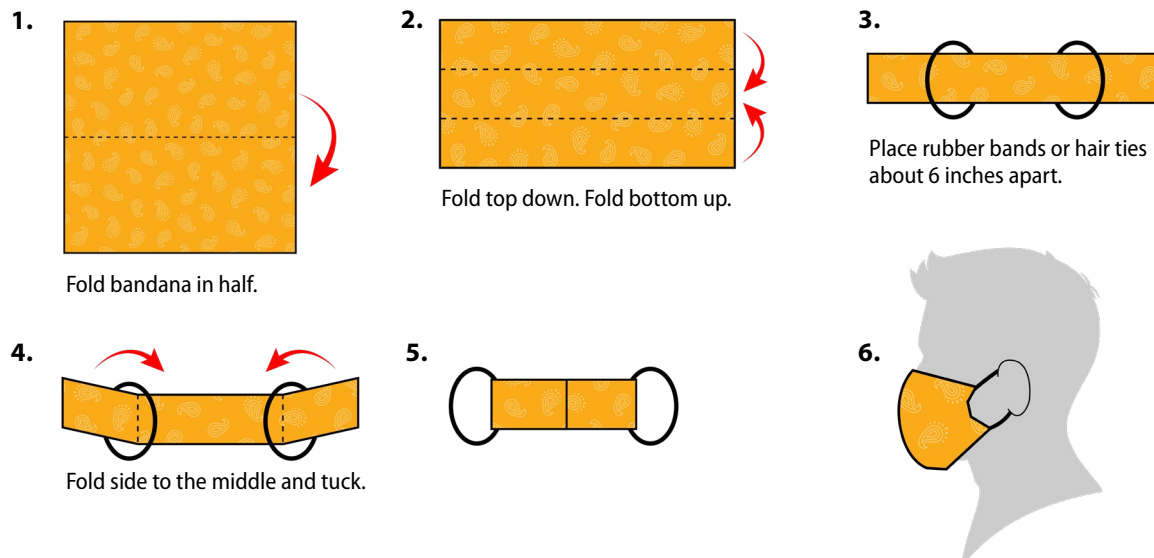

# Coronavirus Face Masks: Types & When to Use | Johns Hopkins Medicine

## Coronavirus Face Masks & Protection FAQs

### [Infectious Diseases](#)

Reviewed By:



[Lisa Lockerd Maragakis, M.D., M.P.H.](#)

New information is emerging every day on how the new coronavirus spreads and the best ways to protect against COVID-19. The most effective protections include washing your hands frequently with soap and water and practicing [social and physical distancing](#). However, wearing cloth face masks or coverings in public when social distancing can't be observed does offer protection against spread of COVID-19.

[Lisa Maragakis, M.D., M.P.H.](#), an expert in infection prevention, provides guidance based on Johns Hopkins Medicine policy.

## Should I wear a face mask or covering for coronavirus protection?

The answer depends on who and where you are. At Johns Hopkins, a team of experts in infection prevention, emergency medicine and emergency management is always reviewing the best ways to protect our patients, our staff and the general public. These are our current recommendations.

## Masks for the Public

**The general public:** The virus can spread between people interacting in close proximity — for example via speaking, coughing, or sneezing — even if those people are not exhibiting symptoms. In light of this evidence, wearing a cloth face mask or covering in public places where social distancing can't be observed will help reduce spread of the disease. For example, in a grocery store or on a bus, if you wear a face mask, you help protect those around you in case you cough or sneeze.

54

Federal and state agencies also provide specific recommendations:











## COVID-19 Response

Research advancements and the latest information about safe, in-person care.

COVID-19 Resources



[Request an Appointment](#)

[Find a Doctor](#)

[Find a Job](#)

[Give Now](#)

[Log in to Patient Account](#)

[English](#)

[PATIENT CARE & HEALTH INFO](#)

[DEPARTMENTS & CENTERS](#)

[RESEARCH](#)

[EDUCATION](#)

[FOR MEDICAL PROFESSIONALS](#)

[PRODUCTS & SERVICES](#)

[GIVING TO MAYO CLINIC](#)

# COVID-19: How much protection do face masks offer?

[Print](#)

## COVID-19: How much protection do face masks offer?

**Get answers to your questions about face masks, including how to use them properly.**

[By Mayo Clinic Staff](#)



Can face masks help prevent the spread of coronavirus disease 2019 (COVID-19)? Yes, face masks combined with other preventive measures, such as frequent hand-washing and social distancing, help slow the spread of the disease.

So why weren't face masks recommended at the start of the pandemic? At that time, experts didn't yet know the extent to which people with COVID-19 could spread the virus before symptoms appeared. Nor was it known that some people have COVID-19 but don't have any symptoms. Both groups can unknowingly spread the virus to others.

These discoveries led the U.S. Centers for Disease Control and Prevention (CDC) to do an about-face on face masks. The CDC updated its guidance to recommend widespread use of simple cloth face coverings to help prevent transmission of COVID-19 by people who have the virus but don't know it.

Some public health groups argue that masks should be reserved

for health care providers and point to the critical shortage of surgical masks and N95 masks. The [CDC](#) acknowledged this concern when it recommended cloth masks for the public and not the surgical and N95 masks needed by health care providers.

## How do the different types of masks work?

### Surgical masks

Also called a medical mask, a surgical mask is a loose-fitting disposable mask that protects the wearer's nose and mouth from contact with droplets, splashes and sprays that may contain germs. A surgical mask also filters out large particles in the air. Surgical masks may protect others by reducing exposure to the saliva and respiratory secretions of the mask wearer.

At this time, the U.S. Food and Drug Administration has not approved any type of surgical mask specifically for protection against the [COVID-19](#) virus, but these masks may provide some protection when N95 masks are not available.

### N95 masks

Actually a type of respirator, an N95 mask offers more protection than a surgical mask does because it can filter out both large and small particles. The name indicates that the mask is designed to block 95% of very small particles. Like surgical masks, N95 masks are intended to be disposable. However, researchers are testing ways to disinfect N95 masks so they can be reused.

### Cloth masks

While surgical and N95 masks are in short supply, cloth masks are more accessible and reusable. Although cloth masks and N95 masks have different purposes, both are intended to slow the spread of [COVID-19](#). A cloth mask is worn to help protect others in case the wearer has the virus. An N95 mask helps protect the wearer from getting the virus from others.

Countries that required face masks, testing, isolation and social distancing early in the pandemic seem to have had some success slowing the disease's spread. Common sense also suggests that some protection is better than none. But wearing a cloth face mask will lose any value unless it's combined with frequent hand-washing and social distancing.

Cloth masks are cheap and simple to make. Instructions are easy to find online. Masks can be made from common materials, such as sheets made of tightly woven cotton. The [CDC](#) website even includes directions for no-sew masks made from bandannas and T-shirts. Cloth masks should include multiple layers of fabric.

### How to wear a cloth face mask

Cloth face masks should be worn in public settings where social distancing measures are difficult to maintain, such as in grocery stores, especially in areas of significant community-based transmission.

Here are a few pointers for putting on and taking off a cloth mask:

- Place your mask over your mouth and nose.
- Tie it behind your head or use ear loops and make sure it's snug.
- Don't touch your mask while wearing it.

- If you accidentally touch your mask, wash or sanitize your hands.
- Remove the mask by untying it or lifting off the ear loops without touching the front of the mask or your face.
- Wash your hands immediately after removing your mask.
- Regularly wash your mask with soap and water in the washing machine. It's fine to launder it with other clothes.

Finally, here are a few face mask precautions:

- Don't put masks on anyone who has trouble breathing, or is unconscious or otherwise unable to remove the mask without help.
- Don't put masks on children under 2 years of age.
- Don't use face masks as a substitute for social distancing.

[Share](#)

[Tweet](#)

April 29, 2020

[Show references](#) ▾

[See more In-depth](#)

## See also

[Can COVID-19 \(coronavirus\) spread through food, water, surfaces and pets?](#)

[Convalescent plasma for COVID-19?](#)

[Coronavirus disease 2019 \(COVID-19\)](#)

[Coronavirus disease: What is it and how can I protect myself?](#)

[Cough](#)

[COVID-19 and your mental health](#)

[COVID-19 \(coronavirus\) antibody test: What is it?](#)

[Show more related content](#)

---

## Other Topics in Patient Care & Health Info

[Healthy Lifestyle](#)

[Symptoms A-Z](#)

[Diseases & Conditions A-Z](#)

[Tests & Procedures A-Z](#)

[Drugs & Supplements A-Z](#)

[Appointments](#)

[Patient & Visitor Guide](#)

[Billing & Insurance](#)

[Patient Online Services](#)

Any use of this site constitutes your agreement to the Terms and Conditions and Privacy Policy linked below.

[Terms and Conditions](#)

[Privacy Policy](#)

[Notice of Privacy Practices](#)

[Notice of Nondiscrimination](#)

Mayo Clinic is a nonprofit organization and proceeds from Web advertising help support our mission. Mayo Clinic does not endorse any of the third party products and services advertised.

[Advertising and sponsorship policy](#)

[Advertising and sponsorship opportunities](#)

A single copy of these materials may be reprinted for noncommercial personal use only. "Mayo," "Mayo Clinic," "MayoClinic.org," "Mayo Clinic Healthy Living," and the triple-shield Mayo Clinic logo are trademarks of Mayo Foundation for Medical Education and Research.

# Face Masks for the General Public

May 4, 2020

*An earlier version of this document was communicated to SAGE in April 2020.*

## Summary

Face masks could offer an important tool for contributing to the management of community transmission of Covid19 within the general population. Evidence supporting their potential effectiveness comes from analysis of: (1) the incidence of asymptomatic and pre-symptomatic transmission; (2) the role of respiratory droplets in transmission, which can travel as far as 1-2 meters; and (3) studies of the use of homemade and surgical masks to reduce droplet spread. Our analysis suggests that their use could reduce onward transmission by asymptomatic and pre-symptomatic wearers if widely used in situations where physical distancing is not possible or predictable, contrasting to the standard use of masks for the protection of wearers. If correctly used on this basis, face masks, including homemade cloth masks, can contribute to reducing viral transmission.

## Key points

1. **Asymptomatic (including presymptomatic) infected individuals are infectious.** Without mitigation, the current estimate is that 40%-80% of infections occur from individuals without symptoms<sup>1 2 3 4</sup>. Universal screening of asymptomatic SARS-COV2 in women admitted for delivery in New York City shows that 13.7% were infected, and that asymptomatic women accounted for 88% of infected individuals in the study<sup>5</sup>. Of individuals who do become symptomatic, viral loads are the highest in the presymptomatic and early symptomatic phase, decreasing thereafter<sup>6 7 8 9 10 11 12</sup>.
2. **Respiratory droplets from infected individuals are a major mode of transmission**<sup>13</sup>. This understanding is the basis of the recommendations for physical distancing, and of the PPE guidance for healthcare workers<sup>14</sup>. Droplets do not only come from coughing or sneezing: in a-/pre-symptomatic individuals, droplets are generated via talking and breathing<sup>15</sup>.
3. **Face masks reduce droplet dispersal.** Cloth-based face masks reduce emission of particles by variable amounts, for example Anfinrud *et al*<sup>15</sup> showed that they are almost completely eliminated. Davies *et al*<sup>16</sup> showed that cloth masks filtered viral particles during coughing at about 50 to 100% of the filtration efficiency of surgical masks, depending on fabric, with absolute filtration efficiencies of 50-70%, and about 70-80% for oral bacteria. van der Sande *et al*<sup>17</sup> showed 50% filtering efficiency for airborne particles.

**This evidence supports the conclusion that more widespread risk-based face mask adoption can help to control the Covid-19 epidemic by reducing the shedding of droplets into the environment from asymptomatic individuals.** This is also consistent with the experiences of countries that have adopted this strategy.

Our analysis focuses on the effect of face masks on onward virus transmission, or source control<sup>18</sup>, of infected but symptom-free wearers. This is to be distinguished from the use of face masks as *personal* protection against virus acquisition. We have found only two randomised control trials in the primary literature on the use of face masks to reduce onward transmission; one<sup>19</sup> was underpowered, and the other<sup>20</sup> showed significant reduction when adjusted for actual mask usage in a posthoc analysis. One non-randomized study showed that mask use to prevent onward transmission significantly reduced viral respiratory tract infection in immunocompromised patients.<sup>21</sup> Greenhalgh *et al*<sup>22</sup> and Javid *et al*<sup>23</sup> argue that “absence of evidence” should not be misinterpreted as “evidence of absence”, and in support of face mask usage by the public based on the precautionary principle.

## Policy implications

- Strategies to transition out of lockdown need to take into account the role of both symptomatic and asymptomatic individuals in spreading Covid-19. Face masks can reduce viral shedding into the environment from such individuals. Both commercially available and homemade cloth masks and surgical masks can play a role.
- Face masks may play an important role in situations where social distancing is not possible or unpredictable. These situations include public transport, stores and shopping areas, work places, within households, clinics, hospitals, care-homes, social care, and busy pavements. If used widely and correctly and on a risk basis, face masks, including homemade cloth masks, can reduce viral transmission: benefits of use increase where risk exposure is high and are marginal where its low.
- Public health interventions that involve cost to the public and access to reliable information tend to be taken up faster, more widely or more effectively by higher socio-economic status groups. If the use of cloth face masks in public is made mandatory or highly recommended, interventions may be necessary to ensure that all members of the public have access to these masks and information about proper use, including guidance on washing and re-use appropriate to the domestic environment to ensure that masks themselves do not become fomites..
- While there is anecdotal evidence of individual risk compensation behaviour, at a population level the introduction of safety measures like HIV prevention measures, seatbelts and helmets have led to increased safety and even increased safety oriented behaviour<sup>24</sup>. There is no evidence for individual risk compensation amongst the public during epidemics.
- Clear instructions, that they should be worn in addition to other government measures like physical distancing and handwashing, and that they primarily protect others rather than the wearer, will be necessary to support correct use and avoid risk compensation behaviour. The establishment of standards for manufactured and homemade cloth face masks, as has been done for other areas of public health, is one approach to achieving this.
- In parallel with any policy recommending the use of cloth face masks for the general public, it will be necessary to take all steps to ensure sufficient supply of surgical masks as well as PPE for frontline NHS and social care workers. Use of cloth face masks by the public must not compete with or compromise the supply of PPE for clinical use.

This summary represents the main conclusion of the DELVE Initiative on the wearing of face masks in public, based on a review of the primary literature, and new data-enabled analyses. This evidence base



supports the conclusion that appropriate use of surgical and cloth, including homemade, face masks among the public can have a mitigating effect on the spread of Covid-19.

Technical annexes to this document provide detailed analyses, review additional considerations, and highlight particular practical issues of importance.

## Areas where further investigation is needed

- While there is good indirect supporting evidence that suggests droplets are a main transmission route, the relative contribution of droplet transmission has not yet been directly established empirically.
- Evidence on the extent of transmission from those who remain asymptomatic as opposed to pre-symptomatic transmissions is evolving. Further work on population testing and transmission studies is needed to address these gaps.
- Since risk exposure varies (from 0 to 1), it follows that advice on mask wearing is most useful if it is risk based. Further work is recommended to evaluate & categorise risk exposure, in order to give the public practical advice on when mask use is most and least necessary. Until such studies are definitive, it may be useful to consider whether simple common-sense guidelines could be a constructive interim measure where it is likely that physical distancing may be difficult or unpredictable.
- Mask efficacy depends on material, fit, and other factors. It follows that guidance on risk exposure would be useful (when is a cloth mask adequate, what activity would merit a well-fitted higher-grade mask?).

## Evidence Base

### Current understanding of transmission mechanism and public mask wearing

#### What proportion of transmissions are asymptomatic/presymptomatic?

There is evidence of transmissions from both infected asymptomatic individuals, as well as from presymptomatic individuals, i.e., infectious individuals who will go on to display symptoms but are asymptomatic at the time of transmission<sup>25 26</sup>. Mechanistically, this is related to the high viral load typical of SARS-CoV-2 at the time of symptom onset, as well as evidence of viral shedding occurring prior to the appearance of symptoms<sup>27 28</sup>. One recent paper estimated contributions to the overall reproduction number  $R_0$  arising from asymptomatic ( $R_a$ ), presymptomatic ( $R_p$ ), symptomatic ( $R_s$ ), and environmental transmission ( $R_e$ ), i.e.  $R_0 = R_a + R_p + R_s + R_e$ , and found ratios of  $R_a:R_p:R_s:R_e = 1:9:8:2$ <sup>2</sup>. Note that in this paper, environmental transmission is defined as transmission via contamination; in other words in a way that would not be attributable to contact with the infected source<sup>2</sup>. This is broadly consistent with estimates of 46%-55% presymptomatic transmission in He *et al*<sup>29</sup> as well as estimates of 48% and 62% in data from Singapore and Tianjin<sup>30</sup>. We note that one report estimated that prior to the implementation of travel restrictions on January 23, 2020, in China, up to 79%

of documented cases arose from undocumented infections, many of whom were likely not severely symptomatic<sup>31</sup>.

## What proportion of transmissions are from droplets vs aerosols?

It is currently believed that droplets are the main route of transmission. Whilst there is indirect evidence that supports this, the relative contribution of droplet/aerosol transmission has not been estimated.

Aerosols refer to suspensions in gas of small particles (typically < 5-10 µm) and can travel relatively long distances. Droplets refer to large particles (> 20 µm) and can only travel short distances as they will fall to ground due to gravity<sup>32</sup>. While the possibility of aerosol transmission of COVID-19 has been clearly demonstrated through experiments<sup>33</sup> and outbreak reports (e.g., Washington state choir<sup>34</sup>), it remains unclear what proportion of infection can be attributed to aerosol transmission. Some studies provide indirect evidence that droplets may be the main routes of transmission. For example, a recent report by Lu *et al*<sup>35</sup> describes an outbreak in a restaurant in Guanzhou, China, in which customers were likely to have been infected through droplets that travelled through air conditioning airflow; they conclude that the patterns of outbreak is consistent with droplet transmission, rather than aerosol transmission.

Anfinrud *et al*<sup>15</sup> demonstrates that droplets, smaller than those generated through coughing or sneezing, can be generated via speech, providing further evidence that droplet transmission may play important roles. Public Health England<sup>36</sup> also suggests that droplets and contacts are main routes of transmission. It is currently unknown what proportion of infected cases can be attributed to aerosol vs droplet transmission.

## What proportion of transmissions occur indoors vs outdoors?

Recent analysis from China suggests that a large proportion of transmission occurs indoors, particularly within homes and on transport.

Many outbreak reports describe indoor transmission, including transmission within homes, churches<sup>37</sup>, hospitals<sup>38</sup>, gyms, and restaurants<sup>39</sup>. However, there may be selection bias as indoor transmission is easier to trace and identify. Qian *et al*<sup>40</sup> analyzed 318 outbreaks, involving 3 or more cases, between January 4 and February 11, from China, outside of Hubei province, and found that 80% of the outbreaks are home outbreaks and 34% are transport outbreaks (some outbreaks belong to more than one category); they identified one outbreak in the outdoor setting.

## What are the effects of cloth or homemade masks relative to surgical masks on droplet/aerosol spread and on viral load?

In addition to events such as coughs and sneezes producing respiratory emissions, speech has also been found to produce substantial numbers of droplets capable of containing respiratory pathogens<sup>15</sup>. To this effect, several studies have assessed the usefulness of different types of masks in mitigating emissions from an individual to the environment. Masks made from cloth or household materials have been found to filter pathogens less effectively than surgical masks, with efficiency estimates relative to surgical masks ranging from approximately 70% in a study using bacteria and bacteriophage<sup>41</sup>, to approximately 50% in a study of airborne particles<sup>42</sup>.

In terms of viral load, in a study of influenza, viral RNA was detected in coarse (greater than 5 micron) particles from 11% of the volunteers when they wore surgical masks, and from 43% of the volunteers

when they did not. In fine particles (less than 5 micron in size), viral RNA was detected from 78% of individuals when wearing surgical masks and from 92% of individuals when they did not<sup>43</sup>. This study concluded that the surgical masks produced a 3.4 fold (95% CI 1.8 to 6.3) reduction in viral copies in exhaled breath. Another recent study found that for coronaviruses, surgical face masks reduced virus shedding in respiratory droplets (greater than 5 micron) and aerosols (less than 5 micron) emitted by symptomatic individuals<sup>44</sup>. Specifically, coronaviruses were detected in 30% and 40% of droplet and aerosol samples, respectively, from symptomatic individuals not wearing masks, and in no samples for both droplets and aerosols for symptomatic individuals wearing surgical masks<sup>45</sup>.

## Can masks be decontaminated and re-used?

A few studies (e.g., Mills *et al* 2018<sup>46</sup> and Lore *et al* 2012<sup>47</sup>) have demonstrated that N95 masks can be reused if properly decontaminated (e.g., by using Ultraviolet irradiation). There are multiple studies on the effect of different decontamination procedures, and that these will need to be considered in the development of any guidance on mask use. A recent study by Kumar *et al*<sup>48</sup> showed that decontamination of SARS-CoV-2 on N95 masks can be done without impairing their filtration efficiency for up to 10 cycles depending on the decontamination method. Optimal decontamination procedures for cloth masks need to be determined urgently.

## Observational and RCT Studies of Community Mask Wearing

### Is there direct evidence on mask wearing in the community for decreasing onward transmission?

Virtually all studies on mask usage are focused on their use for the protection of the wearer. These include the studies that are the subject of current meta-analyses and reviews<sup>49 50 51</sup>. Such studies do not answer the question of whether mask use will provide source control.

To our knowledge, only two studies have been performed that studied the effectiveness of mask use by the source patient with a viral respiratory infection (mostly influenza) and tracking the development of viral infection symptoms in others. Both studies used surgical masks and monitored transmission to household members. Both studies have flaws, the most serious of which were sample sizes that were too low or an unexpectedly mild respiratory virus season. One additional study examined the rates of viral respiratory tract infection in bone marrow transplant patients when all health care workers and visitors to the hospital ward wore surgical masks in comparison to infection rates prior to the masking period.<sup>21</sup>

The study by Canini *et al*<sup>52</sup> was stopped early because of poor enrollment; the study had only a 38% chance of detecting a 40% additional protection by masking. Not unexpectedly, the study found no masking effectiveness.

McIntyre *et al*<sup>53</sup> studied the effectiveness of the use of a surgical mask placed on a subject with a viral respiratory infection living in a household of two or more people. They found that 15% of subjects not assigned to mask wearing wore them, while 2% of subjects assigned to wear them did not. Also, probably owing to a mild flu season, only 1 to 2% of household contacts developed illness versus the expected 20%. This resulted in only a 9% chance of detecting a 50% decrease in illnesses in mask-wearing households. However, after adjustments for mask wearing in the index cases, the study found that wearing a surgical mask by the infected person reduced the frequency of viral respiratory infection in household members by 77% (95% CI 11 to 94% reduction).

It is important to note in both studies that mask wearing by the source subjects was still infrequent, around 4 hours a day in both studies. Because of the infrequent use of masks by the source patients, any effect measured can be considered a minimal estimate when considering a recommendation that masks be worn 100% of the time when physical distancing is not possible or predictable in public. These studies focused on the use of surgical masks, rather than cloth, limiting extrapolation.

Sung *et al*<sup>21</sup> studied the effect of a change in surgical mask use on a bone marrow transplant use over a four-year period. Prior to this change, masks were not worn routinely on the unit. Because the patients were hospitalized for longer than the incubation period of viral respiratory tract infections, and were in a HEPA-filtered protective environment, all viral respiratory tract infections in the patients were due to transmission from health care workers and visitors. In comparison to the frequency of viral infection prior to universal mask use, mask use resulted in about a 2.5-fold decrease in patient infections for laboratory-confirmed viral infections, the majority of which were parainfluenza viral infections ( $p < 0.001$ ). To adjust for seasonal and yearly variations in respiratory virus infections, a time-series analysis was conducted, showing a significant reduction (60%,  $p = 0.02$ ) in viral infections due to mask use. Mask compliance was very high, >98%, for both healthcare workers and visitors. A limitation of this study is its before-after design.

## Behavioural considerations

### Does wearing masks lead to more risky behaviour?

There is anecdotal evidence that masks can encourage negative behaviours in professional settings (for instance industry). This is attributable to desensitisation from extended wear and familiarity with the hazardous material. However, there is no direct evidence that this is the case in public settings where there is less chance for desensitisation. Further, at a population level past introductions of safety measures like HIV prevention measures, seatbelts and helmets have led to increased safety and even increased safety oriented behaviour<sup>54</sup>.

### Will universal use of face masks be accepted by the public?

Survey data shows a high uptake of different forms of masks in Italy (81%), a country with no history of widespread mask wearing<sup>55</sup>. An April 15th survey of 1,500 Britons found that 41% of respondents believed that the public should be asked to wear masks, compared to 33% who disagreed<sup>56</sup> so there is some public support for this.

Insights from behavioural science suggest:

- Because people view an action as correct in a given situation to the degree that they see others performing it<sup>57 58</sup>, there is an advantage to encouraging universal application in appropriate settings (such as public transport), with the aim of developing a critical mass of adherence and setting new norms around mask use.
- Because such norms act to inform observers that normative behaviour is both pragmatically prudent and morally proper<sup>59</sup>, information campaigns should convey that others are undertaking proper conduct for both practical and moral reasons, as that combination produces the greatest adherence<sup>60 61</sup>.

- Because, especially in the case of new norms, adherence to a specific form of normative conduct can spur adherence to related forms of normative conduct<sup>62</sup>, the visibility of masks can be expected to act as a reminder of the need for physical distance, increased hand washing, reduced face touching, and group solidarity.
- Because newly installed norms are unfamiliar and potentially unclear, explicit instructions about mask use (e.g., how to wear for adequate coverage and when to end mask use) may be necessary.

## International responses

### What do we know about policy and impact of mask wearing in other countries?

The general approach among countries with policies in place for mask use is to encourage a variety of materials to be used for face masks. Countries that have implemented widespread use of masks early in their national outbreak tend to have flatter curves than those that do not and several officials cite implementing mask policies due to asymptomatic transmission as a reason for this. Whilst this evidence is consistent with a beneficial mask effect, many other factors complicate this picture. Prior experience has been suggested as a factor influencing the nature and implementation of public health policy in countries with outbreaks of SARS and MERS.<sup>63</sup>

#### 1. Policies and Mask Types

In Europe, policy recommendations are mostly geared towards encouraging use of homemade or other non-surgical facial masks for the general population with the aim of providing readily-available protection, while reducing the risks of a limited surgical mask supply becoming unavailable for the healthcare professionals. Mask policies range from recommendations of different forms of homemade masks, from cloths, scarves and bandanas in Germany and the Czech Republic - with fines administered for non-compliance - to government-controlled surgical mask distribution in local pharmacies, such as KF94 masks in South Korea and N95 masks in Taiwan<sup>64</sup>. More information on country policies are attached in the Appendix.

#### 2. Impact

The difference in the rate of increase in cases after the 100th confirmed case in European countries with little or no mask wearing practices such as Spain and Italy, and Asian countries such as Taiwan and Hong Kong with stringent mask policies is notable (see figure below). However, it should be noted that New Zealand's approach - which relies heavily on aggressive testing, tracing and quarantining of virus carriers, with lockdown measures in place - does not include universal mask policies<sup>65</sup>.

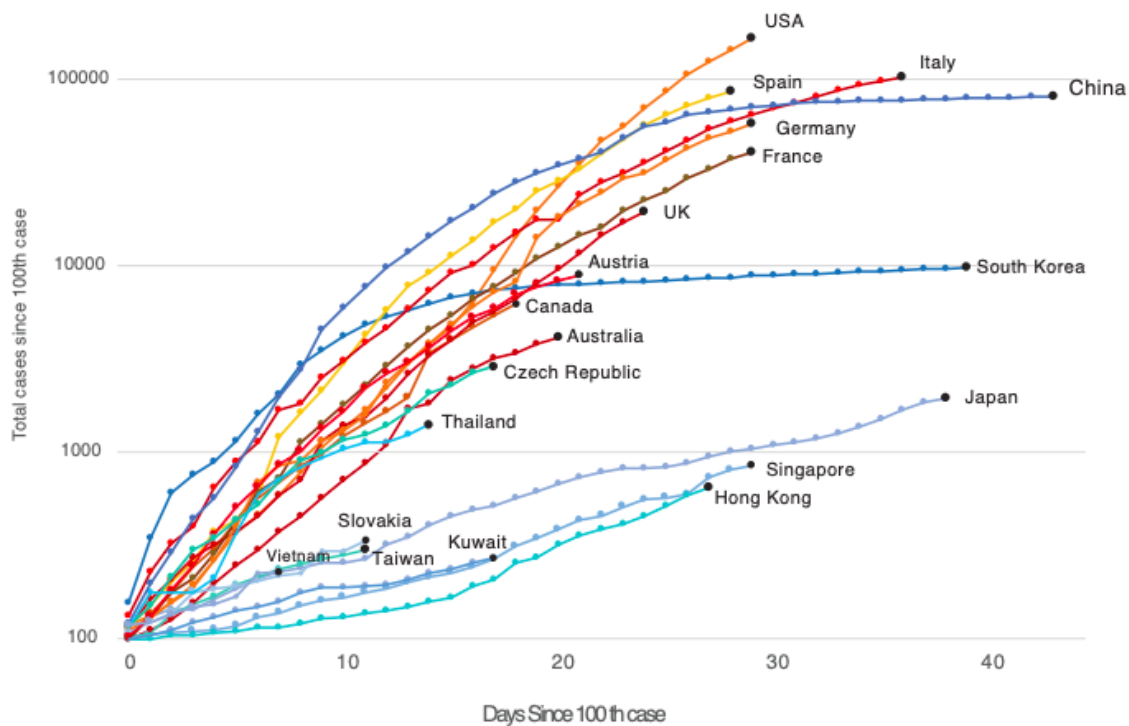

**Figure 3.** Western countries (US, Canada, Australia, UK, Western Europe) with late mask adoption or no use of masks, versus countries and territories with early use of masks as part of official government or in practice policy (China, South Korea, Japan, Hong Kong, Taiwan, Vietnam, Thailand, Kuwait, Slovakia, Czech Republic, in blues and greens). Countries with early mask usage tend to have flatter curves, even without the use of lockdowns.

Fig. 1: Retrieved from Longrich and Sheppard (2020)<sup>66</sup>.

Korea’s government has also witnessed an uptake in mask use due to ease of access: the number of pharmacies that sold all of their mask supplies increased from 67.9% to 86.4% in 11 days<sup>67</sup>.

Similarly, in Hong Kong, a recent survey found that “85% of respondents reported avoiding crowded places and 99% reported wearing face masks when leaving home”<sup>68</sup>. Microbiologist Yuen Kwok-yung from Hong Kong, who helped confirm the spread of COVID-19 in humans has stated that apart from population control, mask-wearing, hand-washing, and social distancing are all necessary and must be implemented early to suppress transmission<sup>69</sup>. This is indicative that clear guidance on mask use aids mask uptake in the community.

Reasons for implementing public mask policies:

In Singapore, National Development Minister Lawrence Wong cited recent fears of asymptomatic spread as one reason for the country’s introduction of mask wearing: “We updated our advice on masks based on the latest scientific evidence: the finding that people without symptoms or very mild symptoms could be spreading the virus”<sup>70</sup>.

The Director General of the Chinese Center for Disease Control and Prevention (CDC) highlights the prevention of virus transmission via droplets expelled during speaking in close contact, particularly from asymptomatic and presymptomatic carriers, in their guidance: “The big mistake in the U.S. and Europe, in my opinion, is that people aren’t wearing masks. Many people have asymptomatic or presymptomatic

infections. If they are wearing face masks, it can prevent droplets that carry the virus from escaping and infecting others<sup>71</sup>.

In Germany, the Robert Koch Institute, the national disease control and prevention agency stated that “some infected people do not become ill at all (asymptomatic infection), but could still pass it on to others. Therefore, the wearing of temporary masks by people entering public places where the safety distance cannot be maintained, e.g. public transport, grocery stores or even at the workplace, could help to reduce the spread of SARS-CoV-2<sup>72</sup>”.

## WHO recommendations

The current World Health Organization (WHO)’s recommendation is to wear a surgical mask to prevent onward transmission only if the wearer is symptomatic or is treating someone suspected to have been infected by COVID<sup>73</sup>. However, this inevitably leads to discrepancies arising from transmissions from those exhibiting no symptoms or are in the pre-symptomatic phase<sup>74</sup>. Further to this, previous studies conducted on the effect of hand hygiene, facemask use and influenza transmission found that hand hygiene alone was insufficient, but when coupled with facemask use, there was reduced transmission<sup>75</sup>. WHO are carrying out further research to understand the efficacy of non-surgical masks and will update their guidance when new evidence is available<sup>76</sup>.

Is there evidence that early adoption of public mask wearing in Czech Republic as compared to Austria mitigated epidemic spread?

There is anecdotal<sup>77</sup> but no conclusive evidence. Government policies of these neighbouring countries largely overlap, with lockdown occurring on the same day. From lockdown, their relative growths in cumulative infection counts match for 2½ weeks, when Austria follows the Czech Republic and also introduces public mask-wearing. At that point new Austrian cases *slow down* compared to the Czech Republic.

It is plausible that Austria’s comparative slow-down 2½ weeks after lockdown should instead be attributed to **more comprehensive testing**, which started 1½ weeks after lockdown. Austria broadened their testing criteria *one week* before enforcing mask-wearing, testing anyone who shows COVID-19 symptoms, as opposed to only those who also fill narrower criteria (e.g. key workers only). The Czech Republic didn’t broaden their testing criteria like Austria did in that period.

## Appendix: Mask policies in different countries

Country	At what point in the spread of disease were masks introduced?	What form of mask is used?	Who is required to wear a mask? In what circumstances?	How is this enforced?
Germany	31 <sup>st</sup> March 2020: Mask use introduced in city of Jena, 2 weeks after	General public encouraged to use home-sewn masks or wear	For those going outside into public spaces i.e. shoppers, those using	Certain cities such as Jena have made mask use mandatory, whereas nation-wide





















	<p>school closures and ban of public gatherings.</p> <p>15<sup>th</sup> April 2020: Announcement from Chancellor Merkel that mask-wearing should extend nationwide, following concern of spread via potential asymptomatic carriers. Germany's first reported case was on 27<sup>th</sup> January and it is beginning to relax current lockdown measures.</p>	<p>protective cloth, rather than medical masks, to prevent shortage of supply for medical professionals and essential workers.</p>	<p>public transport.</p>	<p>these measures are rather recommended.</p>
Czech Republic	<p>19<sup>th</sup> March 2020: 18 days after the first confirmed case. This occurred at the same time commuting became restricted to essential grocery shopping.</p>	<p>If surgical masks are unavailable for public use, any form of cotton material such as folded bandanas and scarves.</p>	<p>Anyone moving outside their home for any reason. People are required to wear protective medical masks and keep a distance of 2m everywhere.</p>	<p>Initially encouraged through a social media campaign that promoted mask use. Now compulsory by law.. Fines for non-compliance.</p>
South Korea	<p>Mid-January 2020: Mask use, particularly for healthcare professionals and those showing respiratory symptoms already in place due to societal practices.</p> <p>9<sup>th</sup> March 2020: Mask distribution policy introduced. This is a 5-day</p>	<p>General population advised to wear KF80 (i.e. FFP1)-type masks. Those required to wear more protective masks (i.e. KF94):</p> <p>1. Those showing respiratory symptoms</p>	<p>Everyone in public, especially showing respiratory symptoms. Those in their personal space (e.g. indoors) and non-crowded areas do not need to wear masks.</p>	<p>Regulated and monitored via social security number. Members of the public can go to a pharmacy on an assigned day of the week, allocated by birth year, and can buy only 2 masks per week. ID required to track purchases to prevent multiple purchases from different pharmacies. Mask availability for</p>



































	<p>rotation system that restricts the number of masks someone can buy, to ensure more equitable distribution and to minimise price-hiking from panic buying.</p> <p>Government bought masks from manufacturers to then distribute to the public to control supply. South Korea's first reported case was announced on 20<sup>th</sup> January and infection control seems to be stable.</p>	<p>(coughing, sneezing, runny/blocked nose, sore throat, producing sputum).</p> <p>2. Those taking care of COVID-19 patients.</p> <p>3. People who visit hospitals or clinics.</p> <p>4. Those working in areas which require them to contact many people (e.g. bus drivers, salesperson, postman, janitor etc.).</p>		<p>every pharmacy can be found via a mobile app.</p>
China	<p>December 2019: Mask use, particularly for healthcare professionals and those showing respiratory symptoms already in place due to societal practices.</p> <p>26<sup>th</sup> January 2020: China's State Council approved subsidies worth USD \$1.63bn for COVID19 efforts to procure more masks. By 27<sup>th</sup></p>	<p>Surgical or disposable masks for those at moderate risk of infection:</p> <p>1. Those working in crowded areas (e.g. hospitals, train stations).</p> <p>2. Those in contact with someone in quarantine.</p> <p>3. Those likely to come into</p>	<p>Those in public areas likely come across other members of the public.</p>	<p>Some provincial differences in enforcement/penalties but it is generally mandatory.</p>















	<p>January, there were nearly 4,500 confirmed cases and 106 deaths. The first reported case was in December 2019, whilst the lockdown in Wuhan occurred on 23<sup>rd</sup> January 2020.</p> <p>19th March 2020: national guidelines introduced for the general population.</p>	<p>contact with COVID19-infected people (e.g. police).</p> <p>Low-risk people should wear disposable masks e.g. those visiting hospitals. A mask should not be used for more than 8 hours in total.</p>		
<p>U.S.A.: State of New York</p>	<p>15<sup>th</sup> April 2020: Governor Cuomo of New York in the process of issuing an executive order to make face coverings obligatory for residents, to take effect on 17<sup>th</sup> April. The state's first confirmed case was reported on 1<sup>st</sup> March; schools and non-business were closed as restrictive measures were put in place from 15<sup>th</sup> March. New York, New Jersey and Maryland are so far the only states to have issued broad orders mandating face coverings in most public settings in the US.</p>	<p>Any form of face covering that masks the mouth and nose; examples include protective masks, scarves and bandanas</p>	<p>Anyone not able to maintain social distancing measures in public and/or crowded areas e.g. on public transport, sidewalks and shops. This is in line with non-binding guidelines from the Centers for Disease Control and Prevention</p>	<p>Cuomo stated that these rules enforced by local governments but no one would be forcibly removed from public transport for non-compliance. Consideration of issuing civil, not criminal, penalties.</p>















# References

1. He X *et al.* 2020 Temporal dynamics in viral shedding and transmissibility of COVID-19. Nat Med (doi: [10.1038/s41591-020-0869-5](https://doi.org/10.1038/s41591-020-0869-5)). 
2. Ferretti L *et al.* 2020 Quantifying SARS-CoV-2 transmission suggests epidemic control with digital contact tracing. Science (doi: [10.1126/science.abb6936](https://doi.org/10.1126/science.abb6936)).   
3. Ganyani, T *et al.* 2020 Estimating the generation interval for COVID-19 based on symptom onset data. medRxiv (doi: [10.1101/2020.03.05.20031815](https://doi.org/10.1101/2020.03.05.20031815)). 
4. Li R *et al.* 2020 Substantial undocumented infection facilitates the rapid dissemination of novel coronavirus (SARS-CoV2). Science (doi: [10.1126/science.abb3221](https://doi.org/10.1126/science.abb3221)). 
5. Sutton D, Fuchs K, D'Alton M, Goffman D. 2020 Universal screening for SARS-COV2 in women admitted for delivery. NEJM (doi: [10.1056/NEJMc2009316](https://doi.org/10.1056/NEJMc2009316)). 
6. Pan X *et al.* 2020 Asymptomatic cases in a family cluster with SARS-CoV-2 infection. The Lancet Infectious Diseases (doi: [10.1016/S1473-3099\(20\)30114-6](https://doi.org/10.1016/S1473-3099(20)30114-6)). 
7. Zou L *et al.* 2020. SARS-CoV-2 Viral Load in Upper Respiratory Specimens of Infected Patients. NEJM (doi: [10.1056/NEJMc2001737](https://doi.org/10.1056/NEJMc2001737)). 
8. Bai Y *et al.* 2020 Presumed Asymptomatic Carrier Transmission of COVID-19. JAMA (doi: [10.1001/jama.2020.2565](https://doi.org/10.1001/jama.2020.2565)). 
9. Hodcroft EB. 2020 Preliminary case report on the SARS-CoV-2 cluster in the UK, France, and Spain. Swiss Medical Weekly (doi: [10.4414/smw.2020.20212](https://doi.org/10.4414/smw.2020.20212)). 
10. He X *et al.* 2020 Temporal dynamics in viral shedding and transmissibility of COVID-19. Nat Med (doi: [10.1038/s41591-020-0869-5](https://doi.org/10.1038/s41591-020-0869-5)). 
11. Tan W *et al.* 2020 Viral Kinetics and Antibody Responses in Patients with COVID-19. MedRxiv (doi: [10.1101/2020.03.24.20042382](https://doi.org/10.1101/2020.03.24.20042382)). 
12. Wölfel, R. *et al.* (2020). Virological assessment of hospitalized patients with COVID-2019. Nature (doi: [10.1038/s41586-020-2196-x](https://doi.org/10.1038/s41586-020-2196-x)). 
13. World Health Organization. 2020 Modes of transmission of virus causing COVID-19: implications for IPC precaution recommendations. See <https://www.who.int/news-room/commentaries/detail/modes-of-transmission-of-virus-causing-covid-19-implications-for-ipc-precaution-recommendations>. 
14. Public Health England. 2020 COVID-19: infection prevention and control guidance, see [https://assets.publishing.service.gov.uk/government/uploads/system/uploads/attachment\\_data/file/881489/COVID-19\\_Infection\\_prevention\\_and\\_control\\_guidance\\_complete.pdf](https://assets.publishing.service.gov.uk/government/uploads/system/uploads/attachment_data/file/881489/COVID-19_Infection_prevention_and_control_guidance_complete.pdf) 
15. Anfinrud P, Stadnytskyi V, Bax CE, Bax A. 2020 Visualizing Speech-Generated Oral Fluid Droplets with Laser Light Scattering. New England Journal of Medicine (doi: [10.1056/NEJMc2007800](https://doi.org/10.1056/NEJMc2007800)).    

16. Davies A *et al.* 2013 Testing the efficacy of homemade masks: would they protect in an influenza pandemic?. *Disaster Medicine and Public Health Preparedness* (doi: [10.1017/dmp.2013.43](https://doi.org/10.1017/dmp.2013.43)). 
17. van der Sande M, Teunis P, Sabel, R. 2008 Professional and home-made face masks reduce exposure to respiratory infections among the general population. *PLoS One* (doi: [10.1371/journal.pone.0002618](https://doi.org/10.1371/journal.pone.0002618)). 
18. Howard J. 2020. To help stop coronavirus, everyone should be wearing face masks. The science is clear. *The Guardian*. See <https://www.theguardian.com/commentisfree/2020/apr/04/why-wear-a-mask-may-be-our-best-weapon-to-stop-coronavirus> 
19. Canini L *et al* 2010. Surgical mask to prevent influenza transmission in households: A cluster randomized trial. *PLoS One* (doi: [10.1371/journal.pone.0013998](https://doi.org/10.1371/journal.pone.0013998)). 
20. MacIntyre C, Zhang Y, Chughtai A, et al. 2016. Cluster randomised controlled trial to examine medical mask use as source control for people with respiratory illness. *BMJ Open* (doi: [10.1136/bmjopen-2016-012330](https://doi.org/10.1136/bmjopen-2016-012330)) 
21. Sung AD, Sung JAM, Thomas S, et al. 2016. Universal Mask Usage for Reduction of Respiratory Viral Infections After Stem Cell Transplant: A Prospective Trial. *Clin Infect Dis*, 63, 999-1006 (doi: [10.1093/cid/ciw451](https://doi.org/10.1093/cid/ciw451)).  <sup>2</sup> <sup>3</sup>
22. Greenhalgh T *et al.* 2020. Face masks for the public during the covid-19 crisis. *BMJ* (doi: [10.1136/bmj.m1435](https://doi.org/10.1136/bmj.m1435)). 
23. Javid B, Weekes MP, Matheson NJ. 2020 Covid-19: should the public wear face masks? *BMJ* (doi: [10.1136/bmj.m1442](https://doi.org/10.1136/bmj.m1442)). 
24. Howard J. 2020. To help stop coronavirus, everyone should be wearing face masks. The science is clear. *The Guardian*. See <https://www.theguardian.com/commentisfree/2020/apr/04/why-wear-a-mask-may-be-our-best-weapon-to-stop-coronavirus> 
25. Rothe C *et al.* 2020 Transmission of 2019-nCoV Infection from an Asymptomatic Contact in Germany. *NEJM* (doi: [10.1056/NEJMc2001468](https://doi.org/10.1056/NEJMc2001468)). 
26. Kimball A et al. 2020 Asymptomatic and Presymptomatic SARS-CoV-2 Infections in Residents of a Long-Term Care Skilled Nursing Facility — King County, Washington, March 2020. *MMWR Morbidity and Mortality Weekly Report*. See <https://www.cdc.gov/mmwr/volumes/69/wr/mm6913e1.htm> 
27. He X *et al.* 2020 Temporal dynamics in viral shedding and transmissibility of COVID-19. *Nat Med* (doi: [10.1038/s41591-020-0869-5](https://doi.org/10.1038/s41591-020-0869-5)). 
28. Zou L *et al.* 2020. SARS-CoV-2 Viral Load in Upper Respiratory Specimens of Infected Patients. *NEJM* (doi: [10.1056/NEJMc2001737](https://doi.org/10.1056/NEJMc2001737)). 
29. He X *et al.* 2020 Temporal dynamics in viral shedding and transmissibility of COVID-19. *Nat Med* (doi: [10.1038/s41591-020-0869-5](https://doi.org/10.1038/s41591-020-0869-5)). 
30. Ganyani, T *et al.* 2020 Estimating the generation interval for COVID-19 based on symptom onset data. *medRxiv* (doi: [10.1101/2020.03.05.20031815](https://doi.org/10.1101/2020.03.05.20031815)). 
31. Li R *et al.* 2020 Substantial undocumented infection facilitates the rapid dissemination of novel coronavirus (SARS-CoV2). *Science* (doi: [10.1126/science.abb3221](https://doi.org/10.1126/science.abb3221)). 

32. Tellier R, Li Y, Cowling BJ, Tang JW. 2019 Recognition of aerosol transmission of infectious agents: a commentary. *BMC Infectious Diseases* (doi: [10.1186/s12879-019-3707-y](https://doi.org/10.1186/s12879-019-3707-y)). 
33. van Doremalen N *et al.* 2020 Aerosol and Surface Stability of HCoV-19 (SARS-CoV-2) Compared to SARS-CoV-1. *MedRxiv* (doi: [10.1056/NEJMc2004973](https://doi.org/10.1056/NEJMc2004973)). 
34. Los Angeles Times. 2020 A choir decided to go ahead with rehearsal. Now dozens of members have COVID-19 and two are dead. See <https://www.latimes.com/world-nation/story/2020-03-29/coronavirus-choir-outbreak>. 
35. Lu P *et al.* 2020. COVID-19 Outbreak Associated with Air Conditioning in Restaurant, Guangzhou, China. *Emerging Infectious Diseases* (doi: [10.3201/eid2607.200764](https://doi.org/10.3201/eid2607.200764)). 
36. Public Health England. 2020 Transmission characteristics and principles of infection prevention and control. See <https://www.gov.uk/government/publications/wuhan-novel-coronavirus-infection-prevention-and-control/transmission-characteristics-and-principles-of-infection-prevention-and-control> 
37. Wei WE *et al.* 2020 Presymptomatic Transmission of SARS-CoV-2 — Singapore, January 23–March 16, 2020. *MMWR Morbidity and Mortality Weekly Report*. See [https://www.cdc.gov/mmwr/volumes/69/wr/mm6914e1.htm?fbclid=IwAR1b\\_S3wC7pqWslF5wUhjMqQWXbxA6rc-YLy80so8Vcxx7160WQHBB0wmx4](https://www.cdc.gov/mmwr/volumes/69/wr/mm6914e1.htm?fbclid=IwAR1b_S3wC7pqWslF5wUhjMqQWXbxA6rc-YLy80so8Vcxx7160WQHBB0wmx4) 
38. Bai Y *et al.* 2020 Presumed Asymptomatic Carrier Transmission of COVID-19. *JAMA* (doi: [10.1001/jama.2020.2565](https://doi.org/10.1001/jama.2020.2565)). 
39. Lu P *et al.* 2020. COVID-19 Outbreak Associated with Air Conditioning in Restaurant, Guangzhou, China. *Emerging Infectious Diseases* (doi: [10.3201/eid2607.200764](https://doi.org/10.3201/eid2607.200764)). 
40. Qian H *et al.* 2020 Indoor transmission of SARS-CoV-2. *MedRxiv* (doi: [10.1101/2020.04.04.20053058](https://doi.org/10.1101/2020.04.04.20053058)). 
41. Davies A *et al.* 2013 Testing the efficacy of homemade masks: would they protect in an influenza pandemic?. *Disaster Medicine and Public Health Preparedness* (doi: [10.1017/dmp.2013.43](https://doi.org/10.1017/dmp.2013.43)). 
42. van der Sande M, Teunis P, Sabel, R. 2008 Professional and home-made face masks reduce exposure to respiratory infections among the general population. *PLoS One* (doi: [10.1371/journal.pone.0002618](https://doi.org/10.1371/journal.pone.0002618)). 
43. Milton DK *et al.* 2013 Influenza Virus Aerosols in Human Exhaled Breath: Particle Size, Culturability, and Effect of Surgical Masks. *Plos Pathogens* (doi: [10.1371/journal.ppat.1003205](https://doi.org/10.1371/journal.ppat.1003205)). 
44. Leung NHL *et al.* 2020 Respiratory virus shedding in exhaled breath and efficacy of face masks. *Nature Medicine* (doi: [10.5061/dryad.w9ghx3fkt](https://doi.org/10.5061/dryad.w9ghx3fkt)). 
45. Leung NHL *et al.* 2020 Respiratory virus shedding in exhaled breath and efficacy of face masks. *Nature Medicine* (doi: [10.5061/dryad.w9ghx3fkt](https://doi.org/10.5061/dryad.w9ghx3fkt)). 
46. Mills D *et al.* 2018 Ultraviolet germicidal irradiation of influenza-contaminated N95 filtering facepiece respirators. *American Journal of Infection Control* (doi: [10.1016/j.ajic.2018.02.018](https://doi.org/10.1016/j.ajic.2018.02.018)). 
47. Lore M *et al.* 2012 Effectiveness of Three Decontamination Treatments against Influenza Virus Applied to Filtering Facepiece Respirators, *The Annals of Occupational Hygiene* (doi:

48. Kumar *et al.* 2020 N95 Mask Decontamination using Standard Hospital Sterilization Technologies. MedRxiv (doi: [10.1101/2020.04.05.20049346](https://doi.org/10.1101/2020.04.05.20049346)). 
49. Brainard JS *et al.* 2020 Facemasks and similar barriers to prevent respiratory illness such as COVID-19: A rapid systematic review. MedRxiv (doi: [10.1101/2020.04.01.20049528](https://doi.org/10.1101/2020.04.01.20049528)). 
50. Xiao J, Shiu EYC, Gao H, et al. 2020. Nonpharmaceutical Measures for Pandemic Influenza in Nonhealthcare Settings–Personal Protective and Environmental Measures. *Emerg Infect Dis*, 26, 967-75. <https://www.ncbi.nlm.nih.gov/pubmed/3202758610.3201/eid2605.190994>. 
51. Cowling BJ, Zhou Y, Ip DK, Leung GM, Aiello AE. 2010. Face masks to prevent transmission of influenza virus: a systematic review. *Epidemiol Infect*, 138, 449-56. <https://www.ncbi.nlm.nih.gov/pubmed/2009266810.1017/S0950268809991658>. 
52. Canini L *et al.* 2010. Surgical mask to prevent influenza transmission in households: A cluster randomized trial. *PLoS One* (doi:[10.1371/journal.pone.0013998](https://doi.org/10.1371/journal.pone.0013998)). 
53. MacIntyre CR *et al.* 2009 Face mask use and control of respiratory virus transmission in households. *Emerg Infect Dis* (doi:[10.3201/eid1502.081166](https://doi.org/10.3201/eid1502.081166)). 
54. Howard J. 2020. To help stop coronavirus, everyone should be wearing face masks. The science is clear. *The Guardian*. See <https://www.theguardian.com/commentisfree/2020/apr/04/why-wear-a-mask-may-be-our-best-weapon-to-stop-coronavirus> 
55. Ipsos MORI. 2020 More people say they're wearing masks to protect themselves from COVID-19 since March. See <https://www.ipsos.com/en/more-people-say-theyre-wearing-masks-protect-themselves-covid-19-march> 
56. The Telegraph. 2020 Support for wearing face masks in public outweighs opposition, 18 April. See <https://www.telegraph.co.uk/news/2020/04/18/public-support-wearing-face-masks-public-outweighs-opposition/> 
57. Farrow K, Grolleau G, Ibanez L. 2017. Social norms and pro-environmental behavior: A review of the evidence. *Ecological Economics* (doi: [10.1016/j.ecolecon.2017.04.017](https://doi.org/10.1016/j.ecolecon.2017.04.017)). 
58. Frank RH. 2020 *Under the Influence: Putting peer pressure to work*. Princeton University Press (ISBN: 9780691193083). 
59. Nolan JM, Schultz PW, Cialdini RB, Goldstein NJ. 2020 The Social Norms Approach: A Wise Intervention for Solving Social and Environmental Problems. *Handbook of Wise Interventions*. 
60. Jacobson RP *et al.* 2020 The Synergistic Effect of Descriptive and Injunctive Norm Perceptions on Counterproductive Work Behaviors. *Journal of Business Ethics* (doi:[10.1007/s10551-018-3968-1](https://doi.org/10.1007/s10551-018-3968-1)). 
61. Cialdini R. 2020 Advice for Reducing Undesirable COVID-19 Behaviors. See <https://www.influenceatwork.com/inside-influence-report/advice-for-reducing-undesirable-covid-19-behaviors/> 
62. Mortensen CH *et al.* 2017 Upward trends: A lever for encouraging behaviors performed by the minority. *Social Psychology and Personality Science* (doi:[10.1177%2F1948550617734615](https://doi.org/10.1177/2F1948550617734615)). 

63. The Guardian 2020. Experience of Sars a key factor in countries' response to coronavirus. 15 March 2020. See: <https://www.theguardian.com/world/2020/mar/15/experience-of-sars-key-factor-in-response-to-coronavirus> 
64. Wong T. 2020 Coronavirus: Why some countries wear face masks and others don't. 31 March. BBC News. See <https://www.bbc.co.uk/news/world-52015486> 
65. Hollingsworth J. 2020 New Zealand reported a decline in new coronavirus cases for the fourth consecutive day. The country is still tightening its border restrictions. 9 April. CNN. See <https://edition.cnn.com/2020/04/09/asia/new-zealand-lessons-intl-hnk/index.html> 
66. Longrich N, Sheppard S. 2020 Public use of face masks to control the coronavirus (SARS-Cov-2) pandemic: a review of theory and evidence. Preprints. 2020040021 See <https://www.preprints.org/manuscript/202004.0021/v2/download>. 
67. Government of Korea. 2020. Flattening the curve on COVID-19: How Korea responded to a pandemic using ICT. See <http://www.korea.kr/common/download.do?fileId=190536078&tblKey=GMN> 
68. Cowling B *et al.* 2020 Impact assessment of non-pharmaceutical interventions against coronavirus disease 2019 and influenza in Hong Kong: an observational study. *Lancet Public Health* (doi: [10.1016/S2468-2667\(20\)30090-6](https://doi.org/10.1016/S2468-2667(20)30090-6)). 
69. Li I, Zuoyan Z. 2020 Q&A with HK microbiologist Yuen Kwok-yung who helped confirm coronavirus' human spread. 10 March. The Straits Times. See <https://www.straitstimes.com/asia/east-asia/exclusive-qa-with-hong-kong-microbiologist-yuen-kwok-yung-who-helped-confirm> 
70. CNA. 2020. COVID-19: Why Singapore changed its guidance on masks and made it mandatory. 14 April. Youtube. See <https://www.youtube.com/watch?v=dWxfZjH2kf8> 
71. Cohen, J. 2020. Not wearing masks to protect against coronavirus is a 'big mistake,' top Chinese scientist says. 27 March. ScienceMag. See <https://www.sciencemag.org/news/2020/03/not-wearing-masks-protect-against-coronavirus-big-mistake-top-chinese-scientist-says> 
72. The Local. 2020 Germany recommends face masks in shops and public transport. 15 April. See <https://www.thelocal.de/20200415/german-government-pushes-to-make-masks-mandatory-in-public-transport-and-retail> 
73. World Health Organization. 2020 Coronavirus disease (COVID-19) advice for the public: When and how to use masks. See <https://www.who.int/emergencies/diseases/novel-coronavirus-2019/advice-for-public/when-and-how-to-use-masks> 
74. He X *et al.* 2020 Temporal dynamics in viral shedding and transmissibility of COVID-19. *Nat Med* (doi: [10.1038/s41591-020-0869-5](https://doi.org/10.1038/s41591-020-0869-5)). 
75. Wong V, Cowling B, Aiello A. 2014 Hand hygiene and risk of influenza virus infections in the community: A systematic review and meta-analysis. *Epidemiol Infect* (doi:[10.1017/S095026881400003X](https://doi.org/10.1017/S095026881400003X)). 
76. Devlin H, Campbell D. 2020 WHO considers changing guidance on wearing face masks. 1 April. The Guardian. See <https://www.theguardian.com/world/2020/apr/01/all-uk-hospital-staff-and-patients-should-wear-masks-says-doctors-group#maincontent> 

77. Greenhalgh T and Howard J. 2020 Masks for all? The science says yes. See <https://www.fast.ai/2020/04/13/masks-summary/> 

---

## Royal Society DELVE Initiative

Royal Society DELVE Initiative



This is the GitHub Repository of the Royal Society DELVE Initiative



# COMMENTARY: Masks-for-all for COVID-19 not based on sound data

Filed Under: [COVID-19](#) ([/infectious-disease-topics/covid-19](#))

[Lisa M Brosseau, ScD, and Margaret Sietsema, PhD](#) ([/ongoing-programs/news-publishing/news-publishing-staff](#)) | Apr 01, 2020

*Dr. Brosseau (<https://today.uic.edu/experts/lisa-brosseau>) is a national expert on respiratory protection and infectious diseases and professor (retired), University of Illinois at Chicago.*

*Dr. Sietsema (<https://publichealth.uic.edu/?s=sietsema>) is also an expert on respiratory protection and an assistant professor at the University of Illinois at Chicago.*



Vergani\_Fotografia / iStock

In response to the stream of misinformation and misunderstanding about the nature and role of masks and respirators as source control or personal protective equipment (PPE), we critically review the topic to inform ongoing COVID-19 decision-making that relies on science-based data and professional expertise.

As noted in a previous [commentary](http://www.cidrap.umn.edu/news-perspective/2020/03/commentary-covid-19-transmission-messages-should-hinge-science) (<http://www.cidrap.umn.edu/news-perspective/2020/03/commentary-covid-19-transmission-messages-should-hinge-science>), the limited data we have for COVID-19 strongly support the possibility that SARS-CoV-2—the virus that causes COVID-19—is transmitted by inhalation of both droplets and aerosols near the source. It is also likely that people who are pre-symptomatic or asymptomatic throughout the duration of their infection are spreading the disease in this way.

## Data lacking to recommend broad mask use

We do not recommend requiring the general public who do not have symptoms of COVID-19-like illness to routinely wear cloth or surgical masks because:

- There is no scientific evidence they are effective in reducing the risk of SARS-CoV-2 transmission
- Their use may result in those wearing the masks to relax other distancing efforts because they have a sense of protection
- We need to preserve the supply of surgical masks for at-risk healthcare workers.

Sweeping mask recommendations—as many have proposed—will not reduce SARS-CoV-2 transmission, as evidenced by the widespread practice of wearing such masks in Hubei province, China, before and during its mass COVID-19 transmission experience earlier this year. Our review of relevant studies indicates that cloth masks will be ineffective at preventing SARS-CoV-2 transmission, whether worn as source control or as PPE.

Surgical masks likely have some utility as source control (meaning the wearer limits virus dispersal to another person) from a symptomatic patient in a healthcare setting to stop the spread of large cough particles and limit the lateral dispersion of cough particles. They may also have very limited utility as source control or PPE in households.

Respirators, though, are the only option that can ensure protection for frontline workers dealing with COVID-19 cases, once all of the [strategies](https://www.cdc.gov/coronavirus/2019-ncov/hcp/respirators-strategy/index.html) (<https://www.cdc.gov/coronavirus/2019-ncov/hcp/respirators-strategy/index.html>) for optimizing respirator supply have been implemented.

We do not know whether respirators are an effective intervention as source control for the public. A non-fit-tested respirator may not offer any better protection than a surgical mask. Respirators work as PPE only when they are the right size and have been fit-tested to demonstrate they achieve an adequate protection factor. In a time when respirator supplies are limited, we should be saving them for frontline workers to prevent infection and remain in their jobs. 81

These recommendations are based on a review of available literature and informed by professional expertise and consultation. We outline our review criteria, summarize the literature that best addresses these criteria, and describe some activities the public can do to help "flatten the curve" and to protect frontline workers and the general public.

We realize that the public yearns to help protect medical professionals by contributing homemade masks, but there are better ways to help.

## **Filter efficiency and fit are key for masks, respirators**

The best evidence of mask and respirator performance starts with testing filter efficiency and then evaluating fit (facepiece leakage). Filter efficiency must be measured first. If the filter is inefficient, then fit will be a measure of filter efficiency only and not what is being leaked around the facepiece.

### **Filter efficiency**

Masks and respirators work by collecting particles through several physical mechanisms, including diffusion (small particles) and interception and impaction (large particles).<sup>1</sup> N95 filtering facepiece respirators (FFRs) are constructed from electret filter material, with electrostatic attraction for additional collection of all particle sizes.<sup>2</sup>

Every filter has a particle size range that it collects inefficiently. *Above and below this range, particles will be collected with greater efficiency.* For fibrous non-electret filters, this size is about 0.3 micrometers ( $\mu\text{m}$ ); for electret filters, it ranges from 0.06 to 0.1  $\mu\text{m}$ . When testing, we care most about the point of inefficiency. As flow increases, particles in this range will be collected less efficiently.

The best filter tests use worst-case conditions: high flow rates (80 to 90 liters per minute [L/min]) with particle sizes in the least efficiency range. This guarantees that filter efficiency will be high at typical, lower flow rates for all particle sizes. Respirator filter certification tests use 84 L/min, well above the typical 10 to 30 L/min breathing rates. The N95 designation means the filter exhibits at least 95% efficiency in the least efficient particle size range.

Studies should also use well-characterized inert particles (not biological, anthropogenic, or naturogenic ones) and instruments that quantify concentrations in narrow size categories, and they should include an N95 FFR or similar respirator as a positive control.

### **Fit**

Fit should be a measure of how well the mask or respirator prevents leakage around the facepiece, as noted earlier. Panels of representative human subjects reveal more about fit than tests on a few individuals or mannequins.

Quantitative fit tests that measure concentrations inside and outside of the facepiece are more discriminating than qualitative ones that rely on taste or odor.

## **Mask, N95 respirator filtering performance**

Following a recommendation that cloth masks be explored for use in healthcare settings during the next influenza pandemic,<sup>3</sup> The National Institute for Occupational Safety and Health (NIOSH) conducted a study of the filter performance on clothing materials and articles, including commercial cloth masks marketed for air pollution and allergens, sweatshirts, t-shirts, and scarfs.<sup>4</sup>

Filter efficiency was measured across a wide range of small particle sizes (0.02 to 1  $\mu\text{m}$ ) at 33 and 99 L/min. N95 respirators had efficiencies greater than 95% (as expected). For the entire range of particles tested, t-shirts had 10% efficiency, scarves 10% to 20%, cloth masks 10% to 30%, sweatshirts 20% to 40%, and towels 40%. All of the cloth masks and materials had near zero efficiency at 0.3  $\mu\text{m}$ , a particle size that easily penetrates into the lungs.<sup>4</sup>

Another study evaluated 44 masks, respirators, and other materials with similar methods and small aerosols (0.08 and 0.22  $\mu\text{m}$ ).<sup>5</sup> N95 FFR filter efficiency was greater than 95%. Medical masks exhibited 55% efficiency, general masks 38% and handkerchiefs 2% (one layer) to 13% (four layers).

These studies demonstrate that cloth or homemade masks will have very low filter efficiency (2% to 38%). Medical masks are made from a wide range of materials, and studies have found a wide range of filter efficiency (2% to 98%), with most exhibiting 30% to 50% efficiency.<sup>6-12</sup>

We reviewed other filter efficiency studies of makeshift cloth masks made with various materials. Limitations included challenge aerosols that were poorly characterized<sup>13</sup> or too large<sup>14-16</sup> or flow rates that were too low.<sup>17</sup>

### **Mask and respirator fit**

Regulators have not developed guidelines for cloth or surgical mask fit. N95 FFRs must achieve a fit factor (outside divided by inside concentration) of at least 100, which means that the facepiece must lower the outside concentration by 99%, according to the [OSHA respiratory protection standard \(https://www.osha.gov/laws-regs/regulations/standardnumber/1910/1910.134\)](https://www.osha.gov/laws-regs/regulations/standardnumber/1910/1910.134). When fit is measured on a mask with inefficient filters, it is really a measure of the collection of particles by the filter plus how well the mask prevents particles from leaking around the facepiece.

Several studies have measured the fit of masks made of cloth and other homemade materials.<sup>13,18,19</sup> We have not used their results to evaluate mask performance, because none measured filter efficiency or included respirators as positive controls.

One study of surgical masks showing relatively high efficiencies of 70% to 95% using NIOSH test methods measured total mask efficiencies (filter plus facepiece) of 67% to 90%.<sup>7</sup> These results illustrate that surgical masks, even with relatively efficient filters, do not fit well against the face.

In sum, cloth masks exhibit very low filter efficiency. Thus, even masks that fit well against the face will not prevent inhalation of small particles by the wearer or emission of small particles from the wearer.

One study of surgical mask fit described above suggests that poor fit can be somewhat offset by good filter collection, but will not approach the level of protection offered by a respirator. The problem is, however, that many surgical masks have very poor filter performance. Surgical masks are not evaluated using worst-case filter tests, so there is no way to know which ones offer better filter efficiency.

### **Studies of performance in real-world settings**

Before recommending them, it's important to understand how masks and respirators perform in households, healthcare, and other settings.

#### **Cloth masks as source control**

A historical overview of cloth masks notes their use in US healthcare settings starting in the late 1800s, first as source control on patients and nurses and later as PPE by nurses.<sup>20</sup>

Kellogg,<sup>21</sup> seeking a reason for the failure of cloth masks required for the public in stopping the 1918 influenza pandemic, found that the number of cloth layers needed to achieve acceptable efficiency made them difficult to breathe through and caused leakage around the mask. We found no well-designed studies of cloth masks as source control in household or healthcare settings.

In sum, given the paucity of information about their performance as source control in real-world settings, along with the extremely low efficiency of cloth masks as filters and their poor fit, there is no evidence to support their use by the public or healthcare workers to control the emission of particles from the wearer.

#### **Surgical masks as source control**

Household studies find very limited effectiveness of surgical masks at reducing respiratory illness in other household members.<sup>22-25</sup>

Clinical trials in the surgery theater have found no difference in wound infection rates with and without surgical masks.<sup>26-</sup>

<sup>29</sup> Despite these findings, it has been difficult for surgeons to give up a long-standing practice.<sup>30</sup>

There is evidence from laboratory studies with coughing infectious subjects that surgical masks are effective at preventing emission of large particles<sup>31-34</sup> and minimizing lateral dispersion of cough particles, but with simultaneous displacement of aerosol emission upward and downward from the mask.<sup>35</sup>

There is some evidence that surgical masks can be effective at reducing overall particle emission from patients who have multidrug-resistant tuberculosis,<sup>36</sup> cystic fibrosis,<sup>34</sup> and influenza.<sup>33</sup> The latter found surgical masks decreased emission of large particles (larger than 5 µm) by 25-fold and small particles by threefold from flu-infected patients.<sup>33</sup> Sung<sup>37</sup> found a 43% reduction in respiratory viral infections in stem-cell patients when everyone, including patients, visitors, and healthcare workers, wore surgical masks.

In sum, wearing surgical masks in households appears to have very little impact on transmission of respiratory disease. One possible reason may be that masks are not likely worn continuously in households. These data suggest that surgical masks worn by the public will have no or very low impact on disease transmission during a pandemic.

There is no evidence that surgical masks worn by healthcare workers are effective at limiting the emission of small particles or in preventing contamination of wounds during surgery.

There is moderate evidence that surgical masks worn by patients in healthcare settings can lower the emission of large particles generated during coughing and limited evidence that small particle emission may also be reduced.

### **N95 FFRs as source control**

Respirator use by the public was reviewed by [NIOSH \(https://blogs.cdc.gov/niosh-science-blog/2018/01/04/respirators-public-use/\)](https://blogs.cdc.gov/niosh-science-blog/2018/01/04/respirators-public-use/): (1) untrained users will not wear respirators correctly, (2) non-fit tested respirators are not likely to fit, and (3) improvised cloth masks do not provide the level of protection of a fit-tested respirator.

There are few studies examining the effectiveness of respirators on patients. An N95 FFR on coughing human subjects showed greater effectiveness at limiting lateral particle dispersion than surgical masks (15 cm and 30 cm dispersion, respectively) in comparison to no mask (68 cm).<sup>35</sup> Cystic fibrosis patients reported that surgical masks were tolerable for short periods, but N95 FFRs were not.<sup>34</sup>

In summary, N95 FFRs on patients will not be effective and may not be appropriate, particularly if they have respiratory illness or other underlying health conditions. Given the current extreme shortages of respirators needed in healthcare, we do not recommend the use of N95 FFRs in public or household settings.

### **Cloth masks as PPE**

A randomized trial comparing the effect of medical and cloth masks on healthcare worker illness found that those wearing cloth masks were 13 times more likely to experience influenza-like illness than those wearing medical masks.<sup>38</sup>

In sum, very poor filter and fit performance of cloth masks described earlier and very low effectiveness for cloth masks in healthcare settings lead us to conclude that cloth masks offer no protection for healthcare workers inhaling infectious particles near an infected or confirmed patient.

### **Surgical masks as PPE**

Several randomized trials have not found any statistical difference in the efficacy of surgical masks versus N95 FFRs at lowering infectious respiratory disease outcomes for healthcare workers.<sup>39-43</sup>

Most reviews have failed to find any advantage of one intervention over the other.<sup>23,44-48</sup> Recent meta-analyses found that N95 FFRs offered higher protection against clinical respiratory illness<sup>49,50</sup> and lab-confirmed bacterial infections,<sup>49</sup> but not viral infections or influenza-like illness.<sup>49</sup>

A recent pooled analysis of two earlier trials comparing medical masks and N95 filtering facepiece respirators **with controls** (no protection) found that healthcare workers continuously wearing N95 FFRs were 54% less likely to

experience respiratory viral infections than controls ( $P = 0.03$ ), while those wearing medical masks were only 12% less likely than controls ( $P = 0.48$ ; result is not significantly different from zero).<sup>51</sup>

While the data supporting the use of surgical masks as PPE in real-world settings are limited, the two meta-analyses and the most recent randomized controlled study<sup>51</sup> combined with evidence of moderate filter efficiency and complete lack of facepiece fit lead us to conclude that surgical masks offer very low levels of protection for the wearer from aerosol inhalation. There may be some protection from droplets and liquids propelled directly onto the mask, but a faceshield would be a better choice if this is a concern.

### **N95 FFRs as PPE**

A retrospective cohort study found that nurses' risk of SARS (severe acute respiratory syndrome, also caused by a coronavirus) was lower with consistent use of N95 FFRs than with consistent use of a surgical mask.<sup>52</sup>

In sum, this study, the meta-analyses, randomized controlled trial described above,<sup>49,51</sup> and laboratory data showing high filter efficiency and high achievable fit factors lead us to conclude that N95 FFRs offer superior protection from inhalable infectious aerosols likely to be encountered when caring for suspected or confirmed COVID-19 patients.

The precautionary principle supports higher levels of respiratory protection, such as powered air-purifying respirators, for aerosol-generating procedures such as intubation, bronchoscopy, and acquiring respiratory specimens.

### **Conclusions**

While this is not an exhaustive review of masks and respirators as source control and PPE, we made our best effort to locate and review the most relevant studies of laboratory and real-world performance to inform our recommendations. Results from laboratory studies of filter and fit performance inform and support the findings in real-world settings.

Cloth masks are ineffective as source control and PPE, surgical masks have some role to play in preventing emissions from infected patients, and respirators are the best choice for protecting healthcare and other frontline workers, but not recommended for source control. These recommendations apply to pandemic and non-pandemic situations.

Leaving aside the fact that they are ineffective, telling the public to wear cloth or surgical masks could be interpreted by some to mean that people are safe to stop isolating at home. It's too late now for anything but stopping as much person-to-person interaction as possible.

Masks may confuse that message and give people a false sense of security. If masks had been the solution in Asia, shouldn't they have stopped the pandemic before it spread elsewhere?

### **Ways to best protect health workers**

We recommend that healthcare organizations follow [US Centers for Disease Control and Prevention \(CDC\) guidance](https://www.cdc.gov/coronavirus/2019-ncov/hcp/respirators-strategy/index.html) (<https://www.cdc.gov/coronavirus/2019-ncov/hcp/respirators-strategy/index.html>) by moving first through conventional, then contingency, and finally crisis scenarios to optimize the supply of respirators. We recommend using the CDC's [burn rate calculator](https://www.cdc.gov/coronavirus/2019-ncov/hcp/ppe-strategy/burn-calculator.html) (<https://www.cdc.gov/coronavirus/2019-ncov/hcp/ppe-strategy/burn-calculator.html>) to help identify areas to reduce N95 consumption and working down the [CDC checklist](https://www.cdc.gov/coronavirus/2019-ncov/hcp/checklist-n95-strategy.html) (<https://www.cdc.gov/coronavirus/2019-ncov/hcp/checklist-n95-strategy.html>) for a strategic approach to extend N95 supply.

For readers who are disappointed in our recommendations to stop making cloth masks for themselves or healthcare workers, we recommend instead pitching in to locate N95 FFRs and other types of respirators for healthcare organizations. Encourage your local or state government to organize and reach out to industries to locate respirators not currently being used in the non-healthcare sector and [coordinate donation efforts](https://www.cnbc.com/2020/03/25/apple-and-facebook-face-masks-were-stockpiled-after-wildfires.html) (<https://www.cnbc.com/2020/03/25/apple-and-facebook-face-masks-were-stockpiled-after-wildfires.html>) to frontline health workers.

### **References**

1. **Lee KW, Liu BYH.** On the minimum efficiency and the most penetrating particle size for fibrous filters (<https://www.tandfonline.com/doi/abs/10.1080/00022470.1980.10464592>). *J Air Pollut Control Assoc* 1980 Mar 13;30(4):377-81
2. **Martin SB Jr, Moyer ES.** Electrostatic respirator filter media: filter efficiency and most penetrating particle size effects (<https://www.tandfonline.com/doi/abs/10.1080/10473220050075617>). *Appl Occup Environ Hyg* 2000 Nov 30;15(8):609-17
3. Reusability of facemasks during an influenza pandemic. (<https://www8.nationalacademies.org/onpinews/newsitem.aspx?RecordID=s04272006>) News conference, Apr 27, 2006
4. **Rengasamy S, Eimer B, Shaffer RE.** Simple respiratory protection—evaluation of the filtration performance of cloth masks and common fabric materials against 20-1000 nm size particles. (<https://academic.oup.com/annweb/article/54/7/789/202744>) *Ann Occup Hyg* 2010 Jun 28;54(7):789-98
5. **Jung H, Kim J, Lee S, et al.** Comparison of filtration efficiency and pressure drop in anti-yellow sand masks, quarantine masks, medical masks, general masks, and handkerchiefs. ([http://aaqr.org/files/article/668/36\\_AAQR-13-06-OA-0201\\_991-1002.pdf](http://aaqr.org/files/article/668/36_AAQR-13-06-OA-0201_991-1002.pdf)) *Aerosol Air Qual Res* 2014;14(14):991-1002.
6. **Grinshpun SA, Haruta H, Eninger RM, et al.** Performance of an N95 filtering facepiece particulate respirator and a surgical mask during human breathing: two pathways for particle penetration (<https://oeh.tandfonline.com/doi/full/10.1080/15459620903120086>). *J Occup Environ Hyg* 2009 Jul 22;6(10):593-603
7. **Oberg T, Brosseau LM.** Surgical mask filter and fit performance ([https://www.ajicjournal.org/article/S0196-6553\(07\)00774-2/fulltext](https://www.ajicjournal.org/article/S0196-6553(07)00774-2/fulltext)). *Am J Infect Control* 2008 May;36(4):276-82
8. **Willeke K, Qian Y, Donnelly J, et al.** Penetration of airborne microorganisms through a surgical mask and a dust/mist respirator (<https://www.tandfonline.com/doi/abs/10.1080/15428119691014882>). *Am Ind Hyg Assoc J* 1996;57(4):348-55
9. **Brosseau LM, McCullough NV, Vesley D.** Mycobacterial aerosol collection efficiency of respirator and surgical mask filters under varying conditions of flow and humidity (<https://www.tandfonline.com/doi/abs/10.1080/1047322X.1997.10389533>). *Appl Occup Environ Hyg* 1997;12(6):435-45
10. **Chen CC, Willeke K.** Aerosol penetration through surgical masks ([https://www.ajicjournal.org/article/S0196-6553\(05\)80143-9/fulltext](https://www.ajicjournal.org/article/S0196-6553(05)80143-9/fulltext)). *Am J Infect Control* 1992 Aug;20(4):177-84
11. **McCullough NV, Brosseau LM, Vesley D.** Collection of three bacterial aerosols by respirator and surgical mask filters under varying conditions of flow and relative humidity (<https://www.sciencedirect.com/science/article/abs/pii/S0003487897000227>). *Ann Occup Hyg* 1997 Dec;41(6):677-90
12. **Rengasamy S, Eimer B, Szalajda J.** A quantitative assessment of the total inward leakage of NaCl aerosol representing submicron-size bioaerosol through N95 filtering facepiece respirators and surgical masks (<https://www.tandfonline.com/doi/full/10.1080/15459624.2013.866715>). *J Occup Environ Hyg* 2014 11(6):388-96
13. **Davies A, Thompson KA, Giri K, et al.** Testing the efficacy of homemade masks: would they protect in an influenza pandemic? (<https://www.cambridge.org/core/journals/disaster-medicine-and-public-health-preparedness/article/testing-the-efficacy-of-homemade-masks-would-they-protect-in-an-influenza-pandemic/0921A05A69A9419C862FA2F35F819D55>) *Disaster Med Public Health Prep* 2013 Aug;7(4):413-8
14. **Cherrie JW, Apsley A, Cowie H, et al.** Effectiveness of face masks used to protect Beijing residents against particulate air pollution. (<https://oem.bmj.com/content/75/6/446.long>) *Occup Environ Med* 2018 Jun;75(6):446-52
15. **Mueller W, Horwell CJ, Apsley A, et al.** The effectiveness of respiratory protection worn by communities to protect from volcanic ash inhalation. Part I: filtration efficiency tests. (<https://www.sciencedirect.com/science/article/pii/S1438463917308003?via%3Dihub>) *Int J Hyg Environ Health* 2018 July;221(6):967-76
16. **Bowen LE.** Does that face mask really protect you? (<https://journals.sagepub.com/doi/abs/10.1177/153567601001500204>) *Appl Biosaf* 2010 Jun 1;15(2):67-71
17. **Shakya KM, Noyes A, Kallin R, et al.** Evaluating the efficacy of cloth facemasks in reducing particulate matter exposure. (<https://www.nature.com/articles/jes201642>) *J Expo Sci Environ Epidemiol* 2017 May;27(3):352-7
18. **van der Sande M., Teunis P, Sabel R.** Professional and home-made face masks reduce exposure to respiratory infections among the general population (<https://journals.plos.org/plosone/article?id=10.1371/journal.pone.0002618>). *PLOS One* 2008 Jul 9;3(7):0002618
19. **Derrick JL, Gomersall CD.** Protecting healthcare staff from severe acute respiratory syndrome: filtration capacity of multiple surgical masks ([https://www.journalofhospitalinfection.com/article/S0195-6701\(04\)00479-7/abstract](https://www.journalofhospitalinfection.com/article/S0195-6701(04)00479-7/abstract)). *J Hosp Infect* 2005<sup>86</sup> Apr;59(4):365-8
20. **Chughtai AA, Seale H, MacIntyre CR.** Use of cloth masks in the practice of infection control—evidence and policy gaps (<https://www.ijic.info/article/view/11366>). *Int J Infect Control* 2013 Jun;9(3)

21. **Kellogg WH, MacMillan G.** [An experimental study of the efficacy of gauze face masks.](https://ajph.aphapublications.org/doi/10.2105/AJPH.10.1.34) (<https://ajph.aphapublications.org/doi/10.2105/AJPH.10.1.34>) *Am J Public Health* 1920;10(1):34-42
22. **Saunders-Hastings P, Crispo JA, Sikora L, et al.** [Effectiveness of personal protective measures in reducing pandemic influenza transmission: A systematic review and meta-analysis.](https://www.sciencedirect.com/science/article/pii/S1755436516300858?via%3Dihub) (<https://www.sciencedirect.com/science/article/pii/S1755436516300858?via%3Dihub>) *Epidemics* 2017 Sep;20:1-20
23. **Cowling B J, Zhou Y, Ip DKM, et al.** [Face masks to prevent transmission of influenza virus: a systematic review.](https://www.cambridge.org/core/journals/epidemiology-and-infection/article/face-masks-to-prevent-transmission-of-influenza-virus-a-systematic-review/64D368496EBDE0AFCC6639CCC9D8BC05) (<https://www.cambridge.org/core/journals/epidemiology-and-infection/article/face-masks-to-prevent-transmission-of-influenza-virus-a-systematic-review/64D368496EBDE0AFCC6639CCC9D8BC05>) *Epidemiol Infect* 2010 Jan 22;138(4):449-56
24. **bin-Reza F, Chavarrias VL, Nicoll A, et al.** [The use of masks and respirators to prevent transmission of influenza: a systematic review of the scientific evidence.](https://onlinelibrary.wiley.com/doi/full/10.1111/j.1750-2659.2011.00307.x) (<https://onlinelibrary.wiley.com/doi/full/10.1111/j.1750-2659.2011.00307.x>) *Influenza Other Respir Viruses* 2011 Dec 11;6(4):257-67
25. **MacIntyre CR, Zhang Y, Chughtai AA, et al.** [Cluster randomised controlled trial to examine medical mask use as source control for people with respiratory illness.](https://bmjopen.bmj.com/content/6/12/e012330.long) (<https://bmjopen.bmj.com/content/6/12/e012330.long>) *BMJ Open* 2016 Dec 30;6(12):e012330
26. **Meleny FL.** Infection in clean operative wounds: a nine year study. *Surg Gynecol Obstet* 1935;60:264-75
27. **Orr NWM.** Is a mask necessary in the operating theater? *Ann R Coll Surg Engl* 1981;63:390-2
28. **Mitchell NJ, Hunt S.** [Surgical face masks in modern operating rooms—a costly and unnecessary ritual?](https://www.journalofhospitalinfection.com/article/0195-6701(91)90148-2/pdf) ([https://www.journalofhospitalinfection.com/article/0195-6701\(91\)90148-2/pdf](https://www.journalofhospitalinfection.com/article/0195-6701(91)90148-2/pdf)) *J Hosp Infect* 1991;18(3):239-42
29. **Tunevall TG.** [Postoperative wound infections and surgical face masks: a controlled study.](https://link.springer.com/article/10.1007/BF01658736) (<https://link.springer.com/article/10.1007/BF01658736>). *World J Surg* 1991 May-Jun;15(3):383-7
30. **Belkin NL.** [Masks, barriers, laundering, and gloving: Where is the evidence?](https://aornjournal.onlinelibrary.wiley.com/doi/abs/10.1016/S0001-2092%2806%2963946-X) (<https://aornjournal.onlinelibrary.wiley.com/doi/abs/10.1016/S0001-2092%2806%2963946-X>) *AORN J* 2006 Oct 25;84(4):655-63
31. **Johnson DF, Druce JD, Birch C, et al.** [A quantitative assessment of the efficacy of surgical and N95 masks to filter influenza virus in patients with acute influenza infection.](https://academic.oup.com/cid/article/49/2/275/405108) (<https://academic.oup.com/cid/article/49/2/275/405108>) *Clin Infect Dis* 2009 Jul 15;49(2):275-7
32. **Driessche KV, Hens N, Tilley P, et al.** [Surgical masks reduce airborne spread of \*Pseudomonas aeruginosa\* in colonized patients with cystic fibrosis.](https://www.atsjournals.org/doi/full/10.1164/rccm.201503-0481LE?url_ver=Z39.88-2003&rft_id=ori%3Arid%3Acrossref.org&rft_dat=cr_pub%3Dpubmed&) ([https://www.atsjournals.org/doi/full/10.1164/rccm.201503-0481LE?url\\_ver=Z39.88-2003&rft\\_id=ori%3Arid%3Acrossref.org&rft\\_dat=cr\\_pub%3Dpubmed&](https://www.atsjournals.org/doi/full/10.1164/rccm.201503-0481LE?url_ver=Z39.88-2003&rft_id=ori%3Arid%3Acrossref.org&rft_dat=cr_pub%3Dpubmed&)) *Am J Respir Crit Care Med* 2015 Oct 1;192(7):897-9
33. **Milton DK, Fabian MP, Cowling BJ, et al.** [Influenza virus aerosols in human exhaled breath: particle size, culturability, and effect of surgical masks.](https://journals.plos.org/plospathogens/article?id=10.1371/journal.ppat.1003205) (<https://journals.plos.org/plospathogens/article?id=10.1371/journal.ppat.1003205>) *PLoS Pathog* 2013 Mar;9(3):e1003205
34. **Stockwell RE, Wood ME, He C, et al.** [Face masks reduce the release of \*Pseudomonas aeruginosa\* cough aerosols when worn for clinically relevant periods.](https://www.atsjournals.org/doi/full/10.1164/rccm.201805-0823LE?url_ver=Z39.88-2003&rft_id=ori:rid:crossref.org&rft_dat=cr_pub%3Dpubmed) ([https://www.atsjournals.org/doi/full/10.1164/rccm.201805-0823LE?url\\_ver=Z39.88-2003&rft\\_id=ori:rid:crossref.org&rft\\_dat=cr\\_pub%3Dpubmed](https://www.atsjournals.org/doi/full/10.1164/rccm.201805-0823LE?url_ver=Z39.88-2003&rft_id=ori:rid:crossref.org&rft_dat=cr_pub%3Dpubmed)) *Am J Respir Crit Care Med* 2018 Nov 15;198(10):1339-42
35. **Hui DS, Chow BK, Chu L, et al.** [Exhaled air dispersion during coughing with and without wearing a surgical or N95 mask.](http://dx.plos.org/10.1371/journal.pone.0050845) (<http://dx.plos.org/10.1371/journal.pone.0050845>) *PloS One* 2012;7(12):e50845
36. **Dharmadhikari AS, Mphahlele M, Stoltz A, et al.** [Surgical face masks worn by patients with multidrug-resistant tuberculosis: impact on infectivity of air on a hospital ward.](https://www.atsjournals.org/doi/full/10.1164/rccm.201107-1190OC?url_ver=Z39.88-2003&rft_id=ori:rid:crossref.org&rft_dat=cr_pub%3Dpubmed) ([https://www.atsjournals.org/doi/full/10.1164/rccm.201107-1190OC?url\\_ver=Z39.88-2003&rft\\_id=ori:rid:crossref.org&rft\\_dat=cr\\_pub%3Dpubmed](https://www.atsjournals.org/doi/full/10.1164/rccm.201107-1190OC?url_ver=Z39.88-2003&rft_id=ori:rid:crossref.org&rft_dat=cr_pub%3Dpubmed)) *Am J Respir Crit Care Med* 2012 May 15;185(10):1104-9
37. **Sung AD, Sung JA, Thomas S, et al.** [Universal mask usage for reduction of respiratory viral infections after stem cell transplant: a prospective trial.](https://academic.oup.com/cid/article/63/8/999/2389110) (<https://academic.oup.com/cid/article/63/8/999/2389110>) *Clin Infect Dis* 2016 Oct 15;63(8):999-1006
38. **MacIntyre CR, Seale H, Dung TC, et al.** [A cluster randomised trial of cloth masks compared with medical masks in healthcare workers.](https://bmjopen.bmj.com/content/5/4/e006577.long) (<https://bmjopen.bmj.com/content/5/4/e006577.long>) *BMJ Open* 2015 Apr 22;5(4):e006577
39. **Loeb M, Dafoe N, Mahony J, et al.** [Surgical mask vs N95 respirator for preventing influenza among healthcare workers: a randomized trial.](https://jamanetwork.com/journals/jama/article-abstract/184819) (<https://jamanetwork.com/journals/jama/article-abstract/184819>) *JAMA* 2009 Nov 4;302(17):1865-71
40. **MacIntyre CR, Wang Q, Cauchemez S, et al.** [A cluster randomized clinical trial comparing fit-tested and non-fit-tested N95 respirators to medical masks to prevent respiratory virus infection in health care workers](https://onlinelibrary.wiley.com/doi/full/10.1111/j.1750-2659.2011.00198.x) (<https://onlinelibrary.wiley.com/doi/full/10.1111/j.1750-2659.2011.00198.x>). *Influenza Other Respir Viruses* 2011;5(3):170-9
41. **MacIntyre CR, Wang Q, Rahman B, et al.** [Efficacy of face masks and respirators in preventing upper respiratory tract bacterial colonization and co-infection in hospital healthcare workers—authors' reply](#)

(<https://www.sciencedirect.com/science/article/pii/S009174351400190X>). Prev Med 2014 Aug;65:154

42. **MacIntyre CR, Wang Q, Seale H, et al.** [A randomized clinical trial of three options for N95 respirators and medical masks in health workers](https://www.atsjournals.org/doi/full/10.1164/rccm.201207-1164OC) (<https://www.atsjournals.org/doi/full/10.1164/rccm.201207-1164OC>). Am J Resp Crit Care Med 2013;187(9):960-6
43. **Radonovich LJ, Simberkoff MS, Bessesen MT, et al.** [N95 respirators vs medical masks for preventing influenza among health care personnel: a randomized clinical trial.](https://jamanetwork.com/journals/jama/article-abstract/2749214) (<https://jamanetwork.com/journals/jama/article-abstract/2749214>). JAMA 2019 Sep 3;322(9):824-33
44. **Gralton J, and McLaws ML.** [Protecting healthcare workers from pandemic influenza: N95 or surgical masks?.](https://journals.lww.com/ccmjournal/Abstract/2010/02000/Protecting_healthcare_workers_from_pandemic.40.aspx) ([https://journals.lww.com/ccmjournal/Abstract/2010/02000/Protecting\\_healthcare\\_workers\\_from\\_pandemic.40.aspx](https://journals.lww.com/ccmjournal/Abstract/2010/02000/Protecting_healthcare_workers_from_pandemic.40.aspx)) Crit Care Med 2010 Feb;38(2):657-67
45. bin Reza 2012 (we have Bin-Reza 2011)
46. **Bunyan D, Ritchie L, Jenkins D, et al.** [Respiratory and facial protection: a critical review of recent literature.](https://linkinghub.elsevier.com/retrieve/pii/S0195-6701(13)00280-6) ([https://linkinghub.elsevier.com/retrieve/pii/S0195-6701\(13\)00280-6](https://linkinghub.elsevier.com/retrieve/pii/S0195-6701(13)00280-6)). J Hosp Infect 2013 Nov;85(3):165-9
47. **Smith JD, MacDougall CC, Johnstone J, et al.** [Effectiveness of N95 respirators versus surgical masks in protecting health care workers from acute respiratory infection: a systematic review and meta-analysis.](https://www.cmaj.ca/content/188/8/567.long) (<https://www.cmaj.ca/content/188/8/567.long>) CMAJ 2016 May 17;188(8):567-74
48. **Jefferson T, Jones M, Ansari LAA, et al.** [Physical interventions to interrupt or reduce the spread of respiratory viruses. Part 1 - Face masks, eye protection and person distancing: systematic review and meta-analysis.](https://www.medrxiv.org/content/10.1101/2020.03.30.20047217v1) (<https://www.medrxiv.org/content/10.1101/2020.03.30.20047217v1>) medRxiv 2020 Mar 30
49. **Offeddu V, Yung CF, Low MSF, et al.** [Effectiveness of masks and respirators against respiratory infections in healthcare workers: a systematic review and meta-analysis.](https://academic.oup.com/cid/article/65/11/1934/4068747) (<https://academic.oup.com/cid/article/65/11/1934/4068747>) Clin Infect Dis 2017 Aug 7;65(11):1934-42
50. **Long Y, Hu T, Liu L, et al.** [Effectiveness of N95 respirators versus surgical masks against influenza: A systematic review and meta-analysis.](https://onlinelibrary.wiley.com/doi/full/10.1111/jebm.12381) (<https://onlinelibrary.wiley.com/doi/full/10.1111/jebm.12381>) J Evid Based Med 2020 (published online Mar 13)
51. **MacIntyre CR, Chughtai AA, Rahman B, et al.** [The efficacy of medical masks and respirators against respiratory infection in healthcare workers](https://onlinelibrary.wiley.com/doi/full/10.1111/irv.12474) (<https://onlinelibrary.wiley.com/doi/full/10.1111/irv.12474>). Influenza Other Respir Viruses 2017;11(6):511-7
52. **Loeb M, McGeer A, Henry B, et al.** [SARS among critical care nurses, Toronto.](https://www.ncbi.nlm.nih.gov/pmc/articles/PMC3322898/) (<https://www.ncbi.nlm.nih.gov/pmc/articles/PMC3322898/>) Emerg Infect Dis 2004 Feb;10(2):251-5

Share this page:



## NEWSLETTER SIGN-UP

Get CIDRAP news and other free newsletters.

Sign up now»

## OUR UNDERWRITERS

Unrestricted financial support provided by



PRINCIPAL  
UNDERWRITER



GILEAD  
Advancing Therapeutics.  
Improving Lives.

SUPPORTING  
UNDERWRITER

Grant support for ASP provided by



## RELATED NEWS ALL NEWS

MAY  
09  
2020

**Global COVID-19 total passes 4 million cases**

MAY  
08  
2020

**US job losses due to COVID-19 highest since Great Depression**

MAY  
08  
2020

**COVID-19 battle echoes smallpox; concerns rise over domestic violence in lockdown**

MAY  
08  
2020

**Study finds no hydroxychloroquine effect on death, severe COVID-19**



CIDRAP - Center for Infectious Disease Research and Policy  
Office of the Vice President for Research, University of Minnesota, Minneapolis, MN

© 2020 Regents of the University of Minnesota. All rights reserved.  
The University of Minnesota is an equal opportunity educator and employer.

[CIDRAP](#) | [Office of the Vice President for Research](#) | [Contact U of M](#) | [Privacy Policy](#)

## **FREQUENTLY ASKED QUESTIONS RELATED TO BARBERSHOPS AND COSMETOLOGY SALONS**

**PURSUANT TO EXECUTIVE ORDER 20-120 AS ISSUED MAY 9, 2020**

**EXECUTIVE ORDER 20-120 IS EFFECTIVE ON MONDAY, MAY 11, 2020, AT 12:01 A.M.**

### **PROFESSIONS AUTHORIZED TO REOPEN AND PROVIDE SERVICES**

#### **Which professions does Executive Order 20-120 allow to reopen and provide services?**

*Holders of the following state-issued barber or cosmetology licenses may provide services at establishments that adopt appropriate social distancing and precautionary measures directed in Executive Order 20-120: Barber; Restricted Barber; Cosmetologist; Nail Specialist; Facial Specialist; Full Specialist; Hair Braider; Hair Wrapper; and Body Wrapper. These license holders are permitted to perform the barbering or cosmetology services as authorized by their respective license or registration.*

#### **Are any barber or cosmetology licenses not authorized to reopen pursuant to the order?**

*Holders of a barbering or cosmetology license located in Broward or Miami-Dade are not authorized to provide services under the provisions of Executive Order 20-120. The restrictions of Executive Order 20-112 remain in effect for Broward and Miami-Dade Counties. Future allowances for services in Broward and Miami-Dade remain under consideration in consultation with local leadership.*

### **OCCUPANCY, HOURS, AND APPOINTMENTS**

#### **Must businesses limit capacity in the barbershop or salon?**

*Barbershops and salons must manage capacity of the premises based on an appointment-only schedule and must allow at least 15 minutes between the conclusion of an appointment and the beginning of the next appointment for proper disinfecting practices. Barbershops and salons should take necessary action to limit gatherings in waiting areas prior to and following appointments to the extent necessary to promote appropriate social distancing. Barbershops and salons are encouraged to adopt means of limiting patrons waiting for appointments, such as calling patrons from a waiting vehicle or outdoor waiting area once an available service station is cleaned, prepared, and ready for service of the next patron.*

#### **Are any restrictions in effect for the waiting area of a barbershop or cosmetology salon?**

*Barbershops and salons should remove all unnecessary, frequent-touch items, such as magazines, newspapers, service menus, and any other unnecessary paper products and décor from customer service areas. These businesses should take necessary action to limit gatherings of patrons in waiting areas to the extent necessary to promote appropriate social distancing.*

**The order prohibits group appointments. What constitutes a group for purposes of the order?**

*Executive Order 20-120 restricts appointments to individuals only. Where multiple individuals are seeking joint or co-scheduled appointments to obtain services as a party at the same appointment time, barbershops and salons should restrict the number of individual appointments to the number of available service stations that can be responsibly accommodated while maintaining appropriate social distancing.*

**Must a barbershop or cosmetology salon limit hours of operation?**

*No. Executive Order 20-120 does not restrict the hours of operation of a barbershop or salon. License holders are encouraged to monitor any local government restrictions that may impact the hours of operation of businesses in their area.*

**SAFETY AND SANITATION**

---

**Are licensed professionals required to wear a mask when providing services in the barbershop or salon? How long will the requirement of wearing a mask be in effect?**

*Yes, a mask must be worn by an employee while providing personal services in the barbershop or salon. The requirement to wear a mask while providing services remains in effect until a subsequent order modifies or rescinds this precautionary measure.*

**Do licensed professionals have to wear a particular type of mask while providing services?**

*No.*

**Are licensed professionals required to wear gloves or any other personal protective equipment other than a mask when providing services in the barbershop or salon?**

*No.*

**Are patrons required to wear masks while obtaining services in the barbershop or salon?**

*No. However, barbershops and salons are encouraged to consider providing unworn masks to clients for use during their appointment. As a private business, barbershops and salons may adopt their own policies requiring the use of a mask by patrons obtaining services.*

**Are any other measures expected of barbershops or salons? Are any other measures recommended?**

*Yes. Barbershops and salons should be thoroughly cleaned and disinfected prior to reopening, and disinfection practices should be repeated, at minimum, between each day of operation. All surfaces, tools, and linens should be disinfected, even if the items were cleaned before the barbershop or salon was closed.*

*Barbershops and salons also should take all reasonable steps to ensure that the shop and individual service areas are maintained and operated in a safe and sanitary manner, including particular attention and adherence to existing Florida sanitation regulations applicable to these services and these locations as promulgated in [Rule 61G3-19.011 \(Barbershop Requirements\)](#) and Rule [61G5-20.002 \(Salon Requirements\)](#), Florida Administrative Code.*

**How will the restrictions in Executive Order 20-120 be enforced?**

*The Department of Business and Professional Regulation maintains routine inspection practices at licensed barbershops and salons, which will continue during the effect of this order. The Department will incorporate the restrictions of this order in compliance inspection activities.*

# # #

# STATE OF FLORIDA

## OFFICE OF THE GOVERNOR

### EXECUTIVE ORDER NUMBER 20-120

(Expanding Phase 1: Safe. Smart. Step-by-Step. Plan for Florida's Recovery)

**WHEREAS**, on March 9, 2020, I issued Executive Order 20-52 declaring a state of emergency for the entire State of Florida as a result of COVID-19; and

**WHEREAS**, on April 29, 2020, based on data showing a downward trajectory of hospital visits for influenza-like illness and COVID-19-like syndromic cases, a decrease in percent positive test results, and a significant increase in hospital capacity, I issued Executive Order 20-112 initiating Phase 1 of the Safe. Smart. Step-by-Step. Plan for Florida's Recovery; and

**WHEREAS**, data collected by the Florida Department of Health indicates the State continues to flatten the curve; and

**WHEREAS**, local leadership in Palm Beach County, citing data showing a downward trajectory of influenza-like illness and COVID-like illness and a low percent of new individuals testing positive, has requested that the County proceed to Phase 1.

**NOW, THEREFORE, I, RON DESANTIS**, as Governor of Florida, by virtue of the authority vested in me by Article IV, Section (1)(a) of the Florida Constitution and Chapter 252, Florida Statutes, and all other applicable laws, promulgate the following Executive Order:

Section 1. Palm Beach County to Phase 1

Executive Order 20-112 is extended, with the following modification:

As of the effective date of this order, the restriction in Section 2(A)(2) of Executive Order 20-112 no longer applies to Palm Beach County.

Section 2. Barbershops, Cosmetology Salons, and Cosmetology Specialty Salons

In addition to the Phase 1 services authorized under Sections 2, 3 and 4 of Executive Order 20-112, persons in Florida may provide or obtain services at the following establishments in counties I have authorized to proceed to Phase 1:

Barbershops, cosmetology salons, and cosmetology specialty salons that adopt appropriate social distancing and precautionary measures as outlined by the Department of Business and Professional Regulation at the following link:  
[www.myfloridalicense.com/emergency](http://www.myfloridalicense.com/emergency).

Section 3. Effective Date

This order is effective at 12:01 a.m. on May 11, 2020.

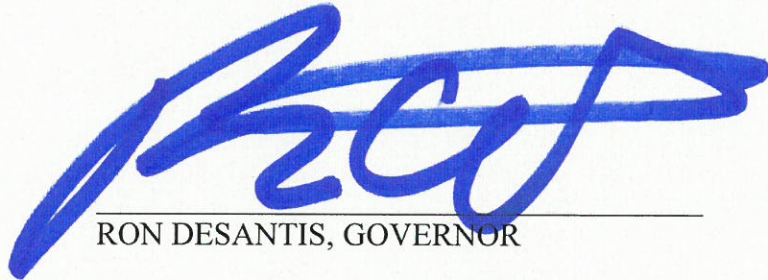

IN TESTIMONY WHEREOF, I have hereunto set my hand and caused the Great Seal of the State of Florida to be affixed, at Tallahassee, this 9th day of May, 2020.

  
\_\_\_\_\_  
RON DESANTIS, GOVERNOR

ATTEST:

  
\_\_\_\_\_  
SECRETARY OF STATE

DEPARTMENT OF STATE  
TALLAHASSEE, FLORIDA  
2020 MAY -9 PM 12: 27

FILED



**FAQs for EXECUTIVE ORDER 20-112**  
Phase 1: **Safe. Smart. Step-by-Step.**  
Plan For Florida's Recovery Post COVID-19 Emergency

## **GENERAL QUESTIONS**

### **When did the Governor's Executive Order take effect? How long does it last?**

The Governor's Executive Order takes effect Monday, May 4, 2020 at 12:01 a.m. and lasts until the Governor issues a subsequent order.

### **Is the "Safer at Home" Order over?**

The Governor's [Executive Order 20-91](#), Essential Services and Activities is extended until 12:01 a.m. Monday, May 4, by Executive Order 20-111. At that point, Executive Order 20-112 will maintain limitations on the movements of persons except for those businesses and services that are currently open and those businesses that re-open at 25 percent building occupancy.

### **Does this order apply to all Florida counties?**

This order is in effect statewide, however in coordination with Miami-Dade, Broward, and Palm Beach county mayors, these three counties will follow stricter protocol without the re-open provisions of Executive Order 20-112.

### **Is the Governor's Executive Order consistent with the President's Opening Up America Again Plan?**

Governor DeSantis met with President Trump on April 28<sup>th</sup> to discuss this plan and the President was very supportive of Florida's efforts to take a safe, smart, step-by-step approach to re-open Florida. See President Trump's guidance here:

[https://www.whitehouse.gov/openingamerica/.](https://www.whitehouse.gov/openingamerica/)

### **Does this Executive Order supersede local law?**

The Governor's [Executive Order 20-91](#) limiting the movements of persons has been incorporated and modified in the new Executive Order 20-112 to include businesses currently open and certain businesses re-opening at 25 percent building occupancy. The Governor's Executive Orders do not contain a preemption on local rules where those rules restrict or close businesses or buildings.

### **When can we expect Phase 2 to start?**

Once the Governor determines it is suitable to continue re-opening and after fully considering medical data in consultation with state health officials.

## **MEDICAL**

### **Can I go to my doctor if it's not COVID-19 related?**

Medical services, including elective procedures, surgical centers, office surgery centers, dental offices, orthodontic offices, endodontic office and other health care practitioners offices may fully re-open. As a condition of resuming elective procedures, hospitals will be required to assist nursing homes and long-term care facilities in their efforts to protect the vulnerable.

However, they must maintain adequate bed capacity and PPE. They must also have the capacity to immediately convert additional surgical and intensive care beds in a surge situation and must not have received or sought any additional federal, state or local government assistance regarding PPE after resuming elective procedures.

**May senior citizens and individuals with significant medical conditions leave their homes to go to the grocery store or pharmacy, or go for a walk, or go to work?**

Yes, they may leave their homes to obtain or provide open services or conduct open activities.

**Can individuals visit nursing homes and long-term care facilities?**

No, those restrictions will remain in place in Phase 1 of the Safe. Smart. Step-by-Step. Plan for Florida's Recovery and with conditions set by the Agency for Health Care Administration.

**TRAVEL**

**Is airport screening and isolation in effect for visitors from highly affected COVID-19 areas?**

Yes, this order extends [Executive Order 20-80](#), Airport Screening and Isolation, and [Executive Order 20-82](#), Isolation of Individuals traveling to Florida, with exceptions for military, emergency, health, infrastructure or commercial related activity.

**BUSINESS**

**Can I open my business?**

Restaurants will be allowed to re-open, with full outdoor seating. Indoor seating will be allowed at 25 percent of building capacity. On-site sale and retail businesses will be allowed to operate at 25 percent occupancy.

If your business is open, it may remain open and should continue appropriate social distancing and sanitation measures. Also, any activity or work that has been available under the previous order remains available. Businesses should adopt appropriate social distancing and sanitation measures.

**What businesses will remain closed?**

Bars, nightclubs and gyms will remain closed during Phase 1 of re-opening. While personal care services such as barbershops and salons with close contact should remain closed, the portions of those businesses with on-site retail sales may re-open at 25 percent building occupancy.

**May my business and its employees continue to operate remotely and provide delivery of our product?**

Yes, all businesses are encouraged to provide delivery or pickup and to take orders online or by telephone.



**Are there minimum health protocols that must be met to open my business?**

Yes, the Governor’s Executive Order 20-112 requires appropriate social distancing and limits groups to 10 people or fewer. Regulated businesses should adhere to agency guidance. Additionally, businesses should consult with the most up-to-date [Centers for Disease Control and Prevention \(CDC\) guidance](#).

**What do I need to do to open my business?**

Review the requirements of the Governor’s Executive Order 20-112. Also review any guidance that has been provided from state and federal regulatory agencies including the Centers for Disease Control and Prevention, the Florida Department of Health and the Florida Department of Business and Professional Regulation.

**Do employee temperature checks need to be done?**

For restaurants, employee protocols remain in place under the Governor’s Executive Order. Other businesses should adopt appropriate measures based on [CDC guidance](#).

**Are masks required for employees and customers?**

The Governor’s Executive Order does not mandate the use of masks. However customers, employees and employers should consult [CDC guidance](#).

**If a business exceeds 25 percent capacity, do they get fined?**

Yes, enforcement penalties remain in place including a second-degree misdemeanor with a fine up to \$500. Certain regulated businesses may face enforcement action for violations from their regulatory agency.

**Should individuals go to facilities that have not re-opened?**

Individuals should travel only to businesses that have been open or are now re-opened.

**Who enforces compliance?**

Local and state law enforcement continue to enforce Executive Orders, along with the regulatory agencies that oversee businesses.

**ACTIVITIES**

**Can I visit or travel to a family member?**

Yes, if caring for or otherwise assisting a loved one or friend.

**May I exercise outside or participate in recreational activities?**

Yes, if consistent with social distancing guidelines as published by the CDC.

**Are gyms open?**

No, gyms and fitness centers should remain closed.

**Can I go to a professional sporting event?**

No, sporting venues may operate but without spectators.

**May churches, synagogues, or other houses of worship hold services?**

Yes. The Governor’s [Executive Order 20-91](#) identified attending religious services at churches, synagogues and places of worship as an open activity. While that order did not

place restrictions directly on any building or venue, many local orders have done so. Any building or venue that is open should continue to follow appropriate social distancing and sanitation procedures.

The Florida Department of Health encourages them to [follow CDC guidance specific to faith organizations](#).

**Can I rent or stay at a vacation rental?**

No, the prohibition on vacation rentals remains in effect.

**Are state parks and beaches open?**

The Governor's Executive Orders have not closed beaches other than those at the request of Broward and Palm Beach counties ([Executive Order 20-90](#)). Florida's Department of Environmental Protection will announce a phased-in re-opening of state parks.

**May childcare centers remain open?**

Yes, if currently able to open and as long as they follow proper social distancing protocols. Florida Department of Education has prioritized children of medical professionals and first responders working at businesses or operations that are essential services, to the extent those childcare centers adhere to social distancing.

**Are museums and libraries open?**

Museums and libraries may open at no more than 25 percent of their building occupancy as long as their local government allows. Interactive shared exhibits, like child play areas, remain closed.

**LOCAL GOVERNANCE & ENFORCEMENT**

**Are local authorities allowed to adopt requirements directly on businesses, operations or venues, including buildings, beaches and parks, that may be stricter than the Governor's Executive Order?**

Yes.

**How is the Governor's Executive Order enforced?**

By law enforcement. Violation of the Governor's Executive Order is a second-degree misdemeanor.

**Where can I report a business that violates the Governor's Executive Order?**

Local law enforcement.

**Do I need a special permit to leave my house if I am going to an essential service or essential activity?**

No. Some businesses may wish to provide a letter to employees to clarify that their business is indeed an open service.

###

# STATE OF FLORIDA

## OFFICE OF THE GOVERNOR

### EXECUTIVE ORDER NUMBER 20-112

(Phase 1: Safe. Smart. Step-by-Step. Plan for Florida's Recovery)

**WHEREAS**, on March 9, 2020, I issued Executive Order 20-52 declaring a state of emergency for the entire State of Florida as a result of COVID-19; and

**WHEREAS**, on April 3, 2020, I issued Executive Order 20-91 and Executive Order 20-92 directing all persons in Florida to limit their movements and personal interactions outside of their home only to those necessary to obtain or provide essential services or conduct essential activities; and

**WHEREAS**, my administration has implemented a data-driven strategy devoted to high-volume testing and aggressive contact tracing, as well as strict screening protocols in long-term care facilities to protect vulnerable residents; and

**WHEREAS**, data collected by the Florida Department of Health indicates the State has achieved several critical benchmarks in flattening the curve, including a downward trajectory of hospital visits for influenza-like illness and COVID-19-like syndromic cases, a decrease in percent positive test results, and a significant increase in hospital capacity since March 1, 2020; and

**WHEREAS**, during the week of April 20, 2020, I convened the Task Force to Re-Open Florida to evaluate how to safely and strategically re-open the State; and

**WHEREAS**, the path to re-opening Florida must promote business operation and economic recovery while maintaining focus on core safety principles.

**NOW, THEREFORE, I, RON DESANTIS**, as Governor of Florida, by virtue of the authority vested in me by Article IV, Section (1)(a) of the Florida Constitution and Chapter 252, Florida Statutes, and all other applicable laws, promulgate the following Executive Order:

Section 1. Phase 1 Recovery

In concert with the efforts of President Donald J. Trump and the White House Coronavirus Task Force, and based on guidance provided by the White House and the Centers for Disease Control and Prevention (CDC), the Occupational Safety and Health Administration (OSHA), and the Florida Surgeon General and State Health Officer, Dr. Scott Rivkees, I hereby adopt the following in response to the recommendations in Phase 1 of the plan published by the Task Force to Re-Open Florida.

Section 2. Responsible Individual Activity

A. All persons in Florida shall continue to limit their personal interactions outside the home; however, as of the effective date of this order, persons in Florida may provide or obtain:

1. All services and activities currently allowed, *i.e.*, those described in Executive Order 20-91 and its attachments, which include activities detailed in Section 3 of Executive Order 20-91, the U.S. Department of Homeland Security in its Guidance on the Essential Critical Infrastructure Workforce and a list propounded by Miami-Dade County in multiple orders (as of April 1, 2020), as well as other services and activities approved by the State Coordinating Officer. Such services should continue to follow safety

guidelines issued by the CDC and OSHA. If necessary, employee screening or use of personal protective equipment should continue.

2. Additional services responsibly provided in accordance with Sections 3 and 4 of this order in counties other than Miami-Dade, Broward and Palm Beach. In Miami-Dade, Broward and Palm Beach counties, allowances for services and activities from Sections 3 and 4 of this order will be considered in consultation with local leadership.

B. Except as provided in Section 2(A)(1) of this order, senior citizens and individuals with a significant underlying medical condition (such as chronic lung disease, moderate-to-severe asthma, serious heart conditions, immunocompromised status, cancer, diabetes, severe obesity, renal failure and liver disease) are strongly encouraged to stay at home and take all measures to limit the risk of exposure to COVID-19.

C. For the duration of this order, all persons in Florida should:

1. Avoid congregating in large groups. Local jurisdictions shall ensure that groups of people greater than ten are not permitted to congregate in any public space that does not readily allow for appropriate physical distancing.
2. Avoid nonessential travel, including to U.S. states and cities outside of Florida with a significant presence of COVID-19.
3. Adhere to guidelines from the CDC regarding isolation for 14 days following travel on a cruise or from any international destination and any area with a significant presence of COVID-19.

D. This order extends Executive Order 20-80 (Airport Screening and Isolation) and Executive Order 20-82 (Isolation of Individuals Traveling to Florida), with exceptions for persons involved in military, emergency, health or infrastructure response or involved in commercial activity. This order extends Sections 1(C) and 1(D) of Executive Order 20-86 (Additional Requirements of Certain Individuals Traveling to Florida), which authorize the Department of Transportation, with assistance from the Florida Highway Patrol and county sheriffs, to continue to implement checkpoints on roadways as necessary.

Section 3. Businesses Restricted by Previous Executive Orders

Unless I direct otherwise, for the duration of this order, the following applies to businesses directly addressed by my previous Executive Orders:

- A. Bars, pubs and nightclubs that derive more than 50 percent of gross revenue from the sale of alcoholic beverages shall continue to suspend the sale of alcoholic beverages for on-premises consumption. This provision extends Executive Order 20-68, Section 1 as modified by Executive Order 20-71, Sections 1 and 2.
- B. Restaurants and food establishments licensed under Chapters 500 or 509, Florida Statutes, may allow on-premises consumption of food and beverage, so long as they adopt appropriate social distancing measures and limit their indoor occupancy to no more than 25 percent of their building occupancy. In addition, outdoor seating is permissible with appropriate social distancing. Appropriate social distancing requires maintaining a minimum of 6 feet between parties, only seating parties of 10 or fewer people and keeping bar counters closed to seating. This provision

extends Executive Order 20-68, Section 3 and supersedes the conflicting provisions of Executive Order 20-71, Section 2 regarding on-premises food consumption.

- C. Gyms and fitness centers closed by Executive Order 20-71 shall remain closed.
- D. The prohibition on vacation rentals in Executive Order 20-87 remains in effect for the duration of this order.
- E. The Department of Business and Professional Regulation shall utilize its authorities under Florida law to implement and enforce the provisions of this order as appropriate.

Section 4. Other Affected Business Services

Unless I direct otherwise, for the duration of this order, the following applies to other business services affected by my previous Executive Orders:

- A. In-store retail sales establishments may open storefronts if they operate at no more than 25 percent of their building occupancy and abide by the safety guidelines issued by the CDC and OSHA.
- B. Museums and libraries may open at no more than 25 percent of their building occupancy, provided, however, that (a) local public museums and local public libraries may operate only if permitted by local government, and (b) any components of museums or libraries that have interactive functions or exhibits, including child play areas, remain closed.

Section 5. Medical Procedures

Subject to the conditions outlined below, elective procedures prohibited by Executive Order 20-72 may resume when this order goes into effect. A hospital ambulatory surgical center, office surgery center, dental office, orthodontic office, endodontic office or other health care

practitioners' office in the State of Florida may perform procedures prohibited by Executive Order 20-72 only if:

- A. The facility has the capacity to immediately convert additional facility-identified surgical and intensive care beds for treatment of COVID-19 patients in a surge capacity situation;
- B. The facility has adequate personal protective equipment (PPE) to complete all medical procedures and respond to COVID-19 treatment needs, without the facility seeking any additional federal or state assistance regarding PPE supplies;
- C. The facility has not sought any additional federal, state, or local government assistance regarding PPE supplies since resuming elective procedures; and
- D. The facility has not refused to provide support to and proactively engage with skilled nursing facilities, assisted living facilities and other long-term care residential providers.

The Agency for Health Care Administration and the Department of Health shall utilize their authority under Florida law to further implement and enforce these requirements. This order supersedes the conflicting provisions of Executive Order 20-72.

Section 6. Previous Executive Orders Extended

The Executive Order 20-69 (Local Government Public Meetings) is extended for the duration of this order.

Section 7. Enforcement

This order shall be enforced under section 252.47, Florida Statutes. Violation of this order is a second-degree misdemeanor pursuant to section 252.50, Florida Statutes, and is punishable by imprisonment not to exceed 60 days, a fine not to exceed \$500, or both.



Section 8.      Effective Date

This order is effective at 12:01 a.m. on May 4, 2020.



IN TESTIMONY WHEREOF, I have hereunto set my hand and caused the Great Seal of the State of Florida to be affixed, at Tallahassee, this 29th day of April, 2020.

  
\_\_\_\_\_  
RON DESANTIS, GOVERNOR

ATTEST:

  
\_\_\_\_\_  
SECRETARY OF STATE

FILED  
2020 APR 29 PM 4:52  
TALLAHASSEE, FLORIDA

# STATE OF FLORIDA

## OFFICE OF THE GOVERNOR

### EXECUTIVE ORDER NUMBER 20-114

(Emergency Management – Extension of Executive Order 20-52 – COVID-19)

**WHEREAS**, on March 1, 2020, I issued Executive Order 20-51, directing the Florida Department of Health to issue a Public Health Emergency due to COVID-19; and

**WHEREAS**, on March 9, 2020, I issued Executive Order 20-52, declaring a state of emergency for the entire state due to COVID-19; and

**WHEREAS**, on March 25, 2020, President Donald J. Trump approved my request and declared a Major Disaster due to COVID-19 in Florida; and

**WHEREAS**, on April 29, 2020, after consulting with my Task Force to Re-Open Florida, I issued Executive Order 20-112, my “Phase 1: Safe. Smart. Step-by-Step. Plan for Florida’s Recovery”; and

**WHEREAS**, I, as Governor of Florida, am committed to providing all available resources and assisting all Floridians and our local communities with their efforts; and

**WHEREAS**, no state of emergency declared pursuant to the Florida Emergency Management Act may continue for more than 60 days unless renewed by the Governor; and

**WHEREAS**, the impact of COVID-19 poses a continuing threat to the health, safety and welfare of the State of Florida and its residents.

**NOW, THEREFORE, I, RON DESANTIS**, as Governor of Florida, by virtue of the authority vested in me by Article IV, Section 1(a) of the Florida Constitution and by the Florida Emergency Management Act, as amended, and all other applicable laws, promulgate the following Executive Order, to take immediate effect:

Section 1. The state of emergency declared in Executive Order 20-52, will be extended for 60 days following the issuance of this order for the entire State of Florida.

Section 2. To the extent Executive Order 20-112, Phase 1: Safe. Smart. Step-by-Step. Plan for Florida's Recovery, amended or extended any executive order related to COVID-19, the referenced executive orders shall remain in effect, as modified.

Section 3. All actions taken by the Director of the Division of Emergency Management as the State Coordinating Officer with respect to this emergency before the issuance of this Executive Order are ratified, and he is directed to continue to execute the State's Comprehensive Emergency Management Plan and other response, recovery, and mitigation plans necessary to cope with the emergency.

Section 4. Except as amended herein, Executive Order 20-52 is ratified and reaffirmed.



IN TESTIMONY WHEREOF, I have hereunto set my hand and caused the Great Seal of the State of Florida to be affixed, at Tallahassee, this 8th day of May, 2020.

A large, stylized handwritten signature in black ink, which appears to be "Ron Desantis".  
\_\_\_\_\_  
RON DESANTIS, GOVERNOR

ATTEST:

A handwritten signature in black ink, which appears to be "Laurel H. Lee".  
\_\_\_\_\_  
SECRETARY OF STATE

DEPARTMENT OF STATE  
TALLAHASSEE, FLORIDA

2020 MAY - 8 AM 8:56

FILED



## Agenda Item Summary

---

Agenda Date: 5/19/2020

Agenda Item No.: 2.

---

**Agenda Item Name:**

Alachua County Sheriff's Office/Gainesville Joint Aviation Unit

**Presenter:**

Click or tap here to enter text.

**Description:**

Click or tap here to enter text.

**Recommended Action:**

Have a discussion on a joint aviation unit.

**Prior Board Motions:**

Click or tap here to enter text.

**Fiscal Consideration:**

TBD

**Background:**

Click or tap here to enter text.